



# WINDOWS & DOORS

HIGHLIGHTS OF ARCHITECTURE

**Internorm**<sup>®</sup>  
Windows – Doors





*Make your dream*  
HOME A REALITY.





# CONTENTS

<b>DESIGN STYLES / INSPIRATION</b>	<b>4</b>
<b>WINDOWS &amp; DOORS</b>	<b>8</b>
<b>uPVC &amp; uPVC-Aluminium</b>	
KF 520 + KF 510 <i>New</i>	10
KF 410 + KF 310	12
KV 440 + KV 350 (integrated blind)	14
KS 430 Lift & Slide Door	16
<b>Timber-Aluminium</b>	
HF 510 <i>New</i>	20
HF 410 + HV 450 (integrated blind)	22
HS 330 Lift & Slide Door	24
HX 300 Panorama	26
<b>Windows &amp; Doors - Overview</b>	28
<b>Renovations</b>	30
<b>Finishes &amp; Accessories</b>	
Perfect Combinations	32
Juliet Balcony	34
Sun & Insect Protection	36
Raffstore External Blinds	38
Blind / Shutter Colours	40
I-tec Innovations	42
Eclaz®	45
Window Security	46
Window Handles	48
Window Colours	50
<b>ENTRANCE DOORS</b>	<b>52</b>
Series.F	54
Series.V <i>New</i>	60
Series.P	64
Series.D	72
Series.G	78
<b>Entrance Doors – Overview</b>	84
<b>Finishes &amp; Accessories</b>	
Entrance Door Handles	86
Entrance Door Colours	90
Ekey Fingerprint Scanner / Keypad	92
<b>SIDE ENTRANCE DOORS</b>	<b>94</b>
<b>WARRANTIES &amp; CERTIFICATION</b>	<b>96</b>
<b>ABOUT US</b>	<b>98</b>









# DESIGN STYLES

## ARCHITECTURAL HIGHLIGHTS

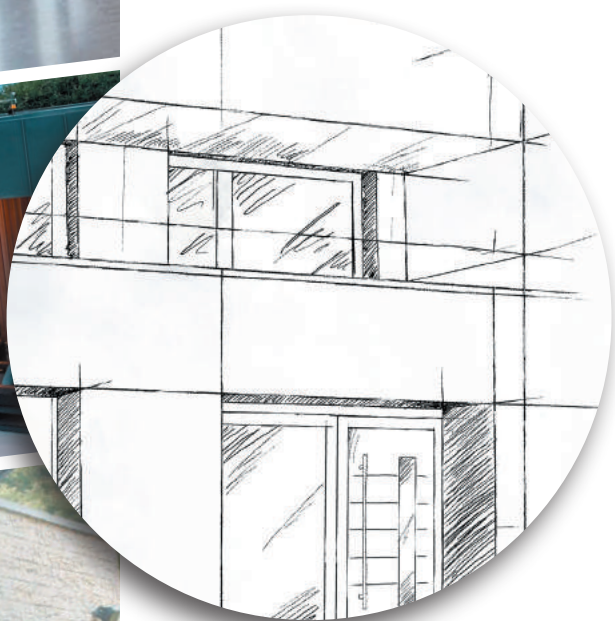

### Windows and doors for your dream home

Architecture is as diverse as the people that live within it. The right windows and doors will add significant character to your home.

Internorm windows and doors allow you to create your individual living space by offering bespoke solutions tailored to your unique requirements. To find the ideal glazing for your project, you can choose from a wide range of colours, materials and accessories, Internorm products also come in four distinct design styles to enhance any architectural design: [studio](#), [home pure](#), [home soft](#) and [ambiente](#).



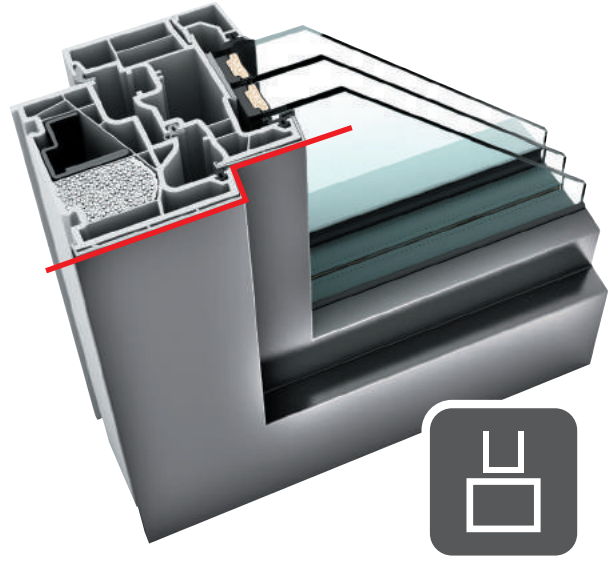
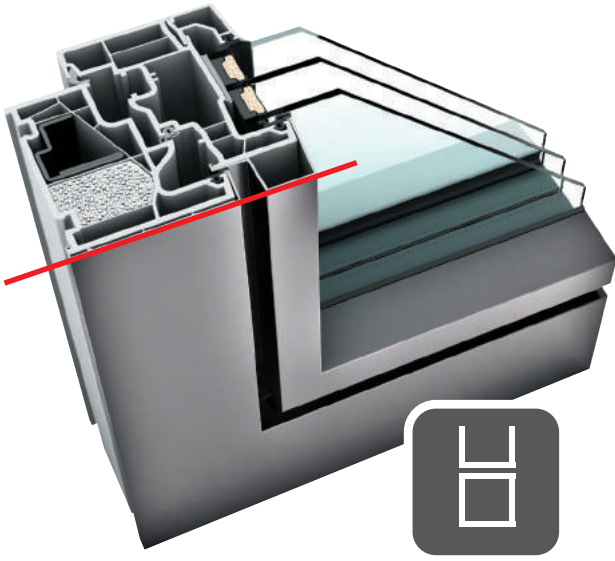

## studio

The **studio** design style is characterised by clean lines and a minimalist design. The windows become a design feature in their own right, whilst enhancing exceptional architecture.

## home pure

The modern **home pure** window with its square edge design perfectly blends into the unique architecture of contemporary buildings.





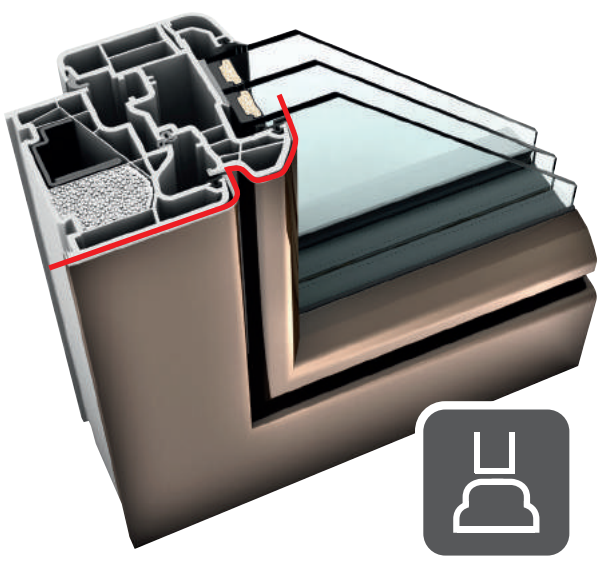
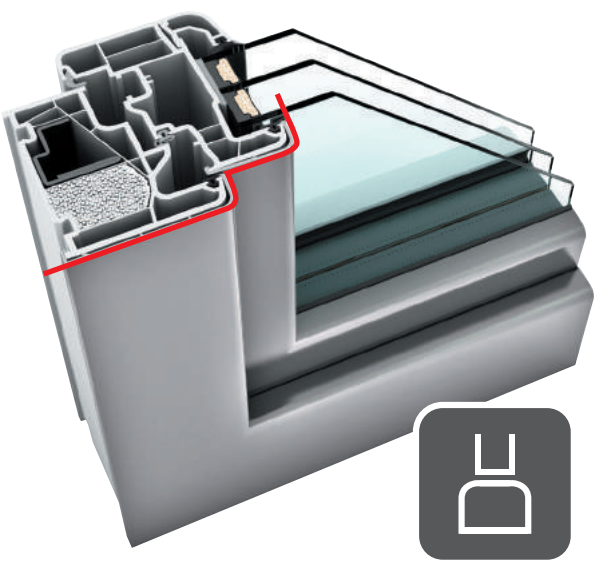

## home soft

The elegant round edge design of a home soft window creates a timeless look that can be integrated effortlessly into any design and architecture.

## ambiente

An ambiente window offers the perfect blend of traditional design and classic detailing. The round profiled edges add a special charm to any façade.





# UPVC & UPVC-ALUMINIUM

CONTEMPORARY. CLEAN. VERSATILE.









# KF 520

## UPVC & UPVC-ALUMINIUM WINDOW

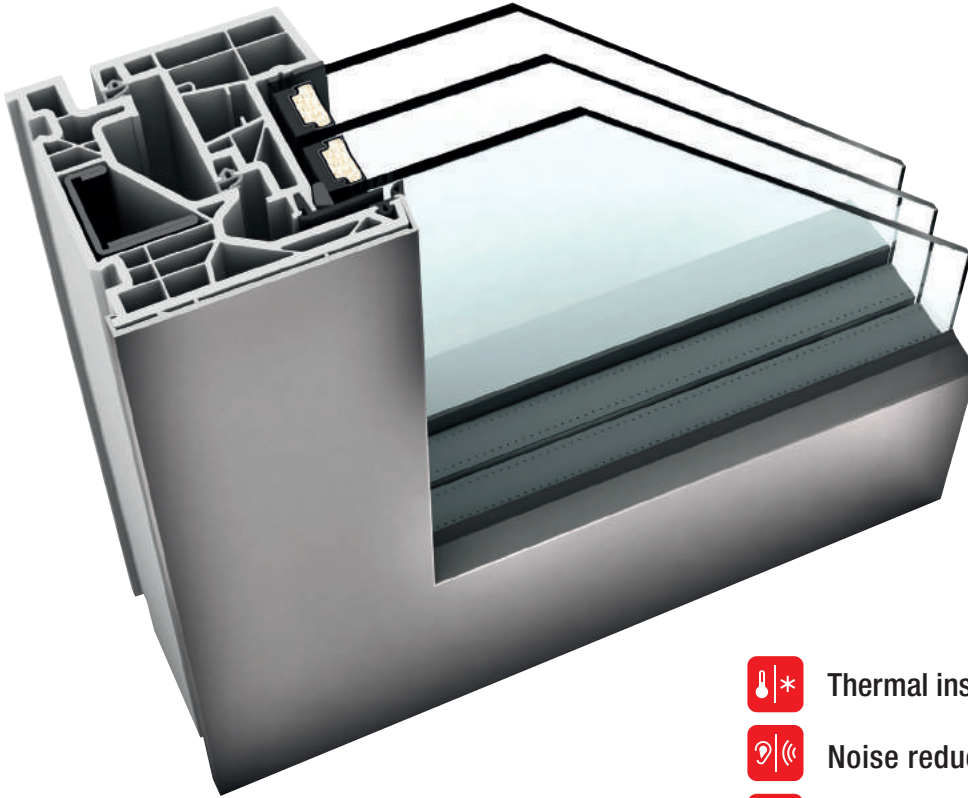

**I-tec Glazing**

**I-tec Secure**

studio



**Thermal insulation**  $U_w$  as low as 0.63 W/(m<sup>2</sup>K)



**Noise reduction** up to 46 dB



**Security** up to RC2, RC3



**Locking** fully integrated



**Construction depth** 90/93 mm

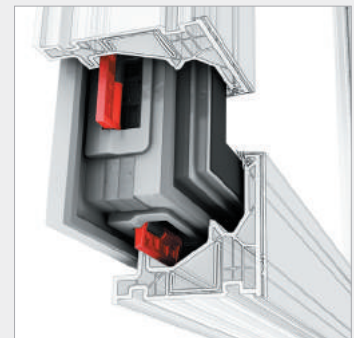
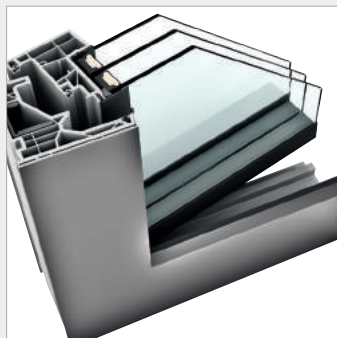
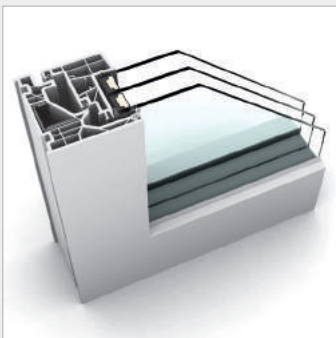

### KF 520

Ideal for modern architecture, this innovative window system looks like fixed glazing from the outside but functions like a normal window. The revolutionary I-tec Secure can achieve the highest RC3 security rating, making it one of the most secure windows on the market.



# KF 510



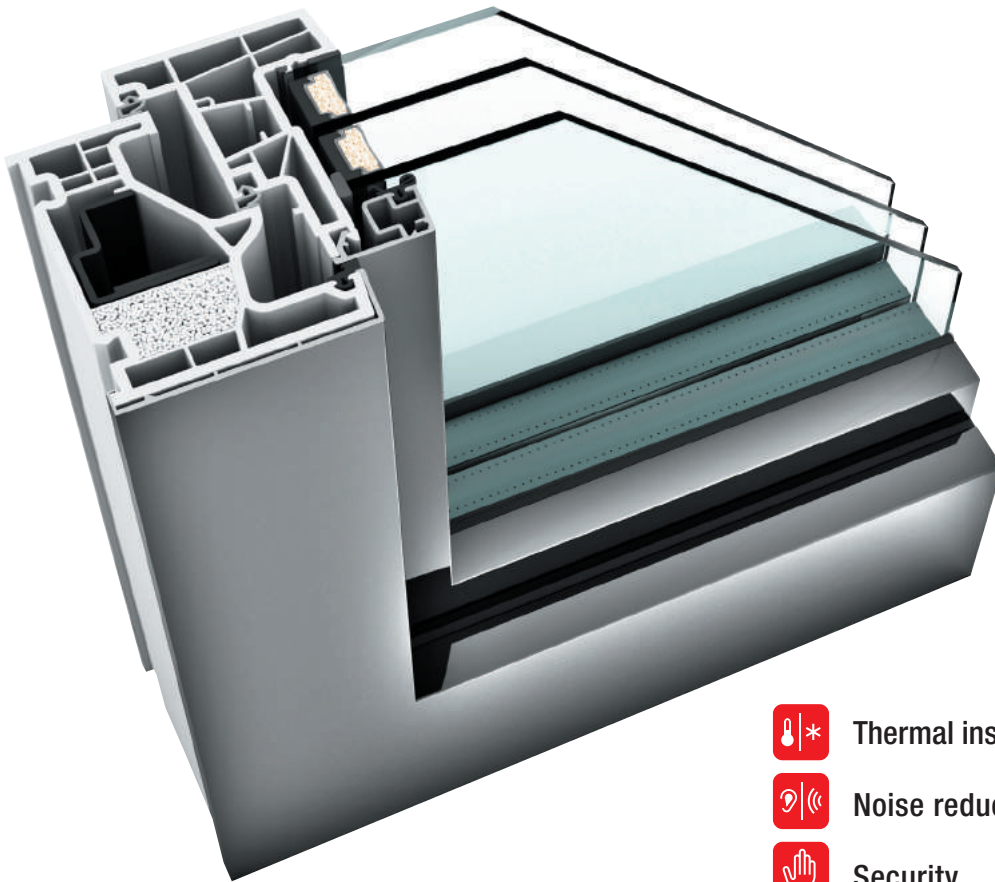

UPVC & UPVC-ALUMINIUM WINDOW



**I-tec** Glazing

**I-tec** Secure

home pure

-  **Thermal insulation**  $U_w$  as low as 0.63 W/(m<sup>2</sup>K)
-  **Noise reduction** up to 46 dB
-  **Security** RC2, RC3
-  **Locking** fully integrated
-  **Construction depth** 90/93 mm

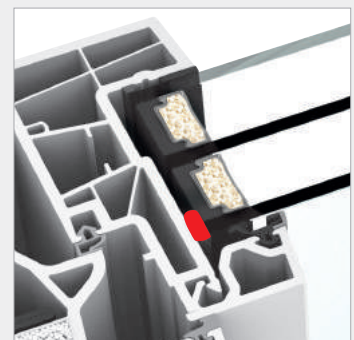
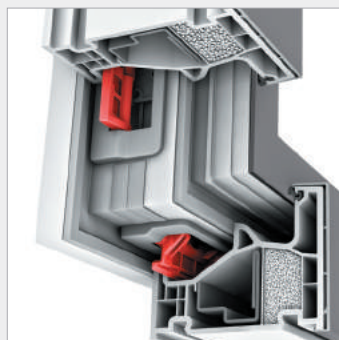
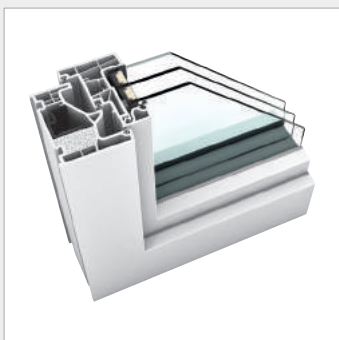

## KF 510

The particularly slim and modern frame of the KF 510 results in an even larger area of glazing to allow maximum light transmission and improved living. The fully integrated I-tec Secure system provides enhanced security thanks to the patented flap mechanism, which presses into all four sides of the frame when locking, making it virtually impossible to lever the window. The concealed hardware also makes it easy to clean, and combined with I-tec Insulation and I-tec Glazing, the new KF 510 offers the ideal window solution.



# KF 410

## UPVC & UPVC-ALUMINIUM WINDOW

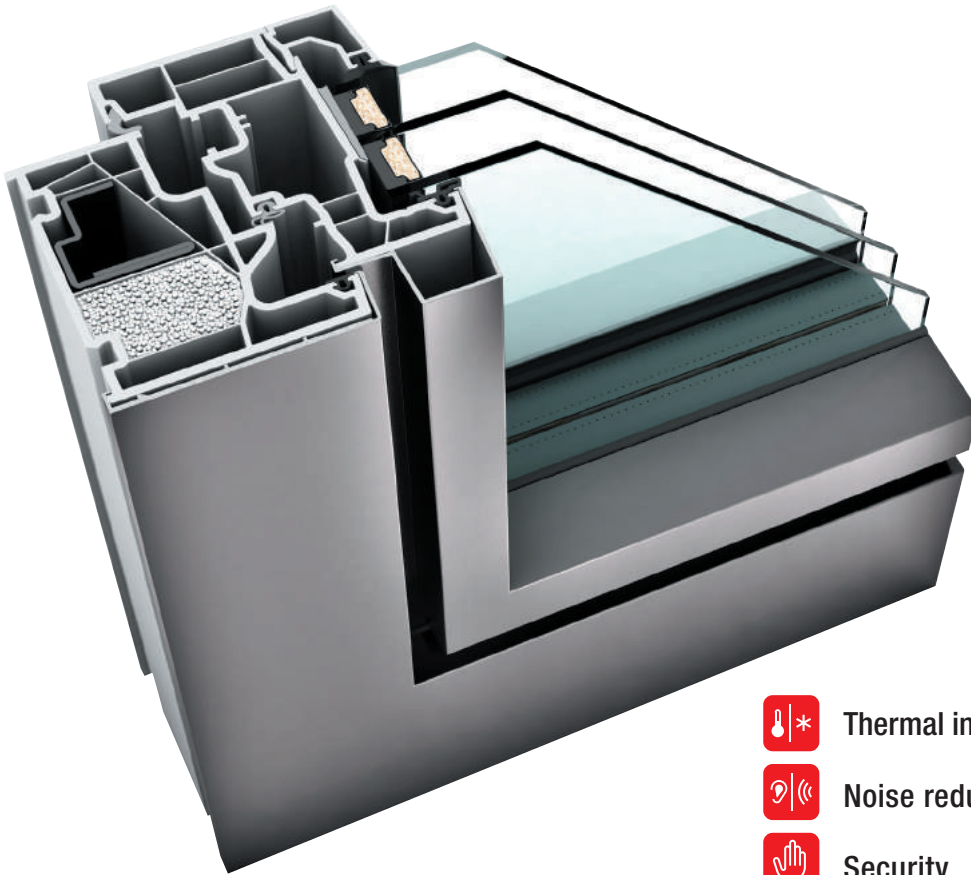

**I-tec** Glazing

**I-tec** Ventilation





**I-tec** Insulation

**I-tec** Connect

home pure

home soft

ambiente

-  **Thermal insulation**  $U_w$  as low as 0.62 W/(m<sup>2</sup>K)
-  **Noise reduction** up to 47 dB
-  **Security** up to RC1N, RC2
-  **Locking** concealed
-  **Construction depth** 90/93 mm

studio

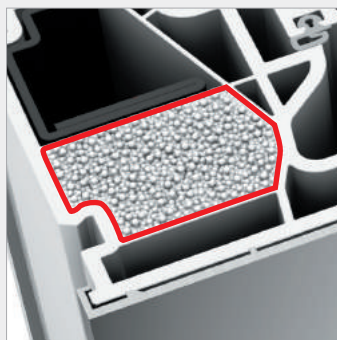
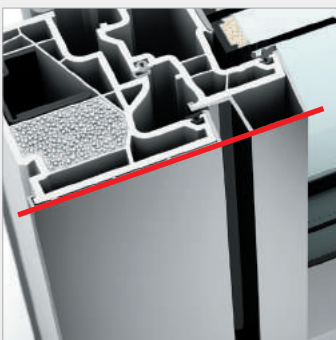

### KF 410

The popular KF 410 is available in all four design styles and is therefore suitable for all types of architecture. I-tec Insulation, which includes insulating granulate that evenly fills the hollow chambers, provides considerable improvement in thermal performance. Also available with I-tec Ventilation to achieve ideal room temperature and living conditions.



# KF 310

## UPVC & UPVC-ALUMINIUM WINDOW

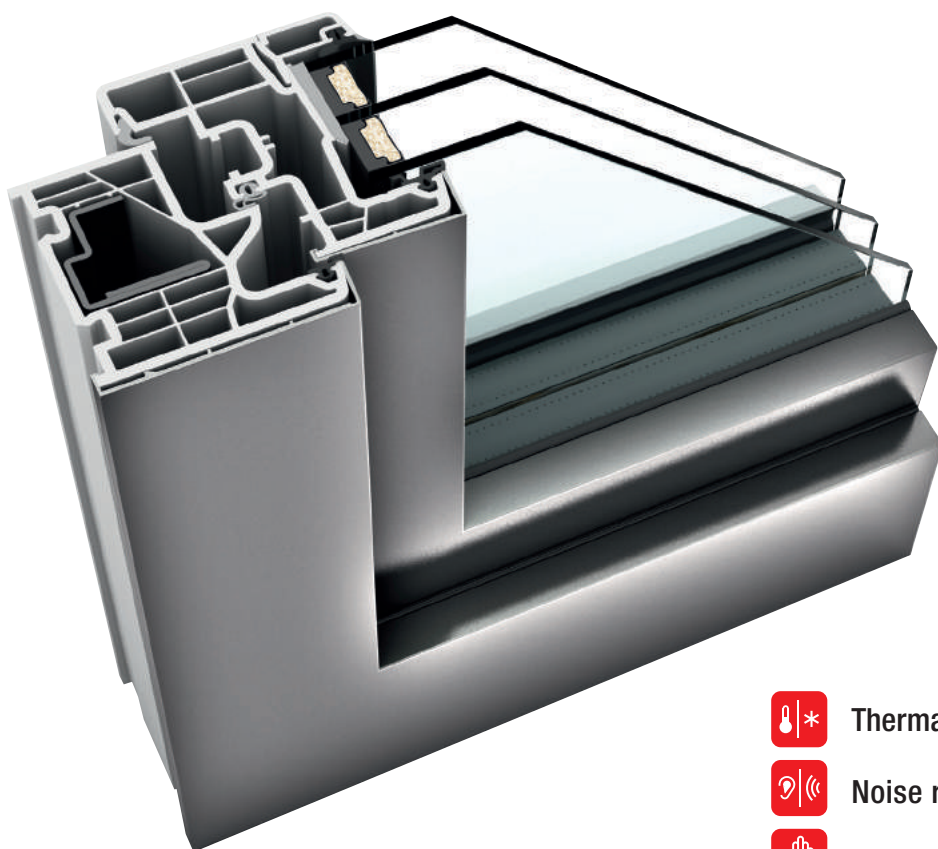





**I-tec** Glazing

home soft

ambiente

home pure

-  **Thermal insulation**  $U_w$  as low as 0.69 W/(m<sup>2</sup>K)
-  **Noise reduction** up to 45 dB
-  **Security** up to RC1N, RC2
-  **Locking** concealed
-  **Construction depth** 71/74 mm

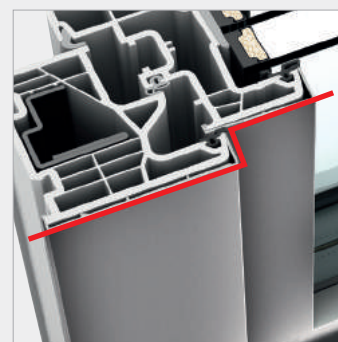
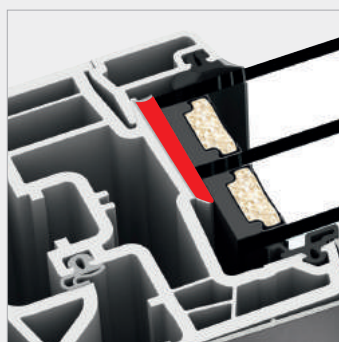
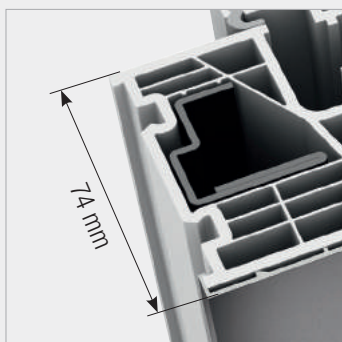

### KF 310

This sleek window features our proven Internorm technology and provides exceptional thermal insulation and noise reduction performance. The KF 310 is also available as a balcony or patio door with an integrated Juliet balcony. Choose from a wide selection of aluminium colours, glazing and handle options.



# KV 440

## UPVC-ALUMINIUM WINDOW WITH INTEGRATED BLIND

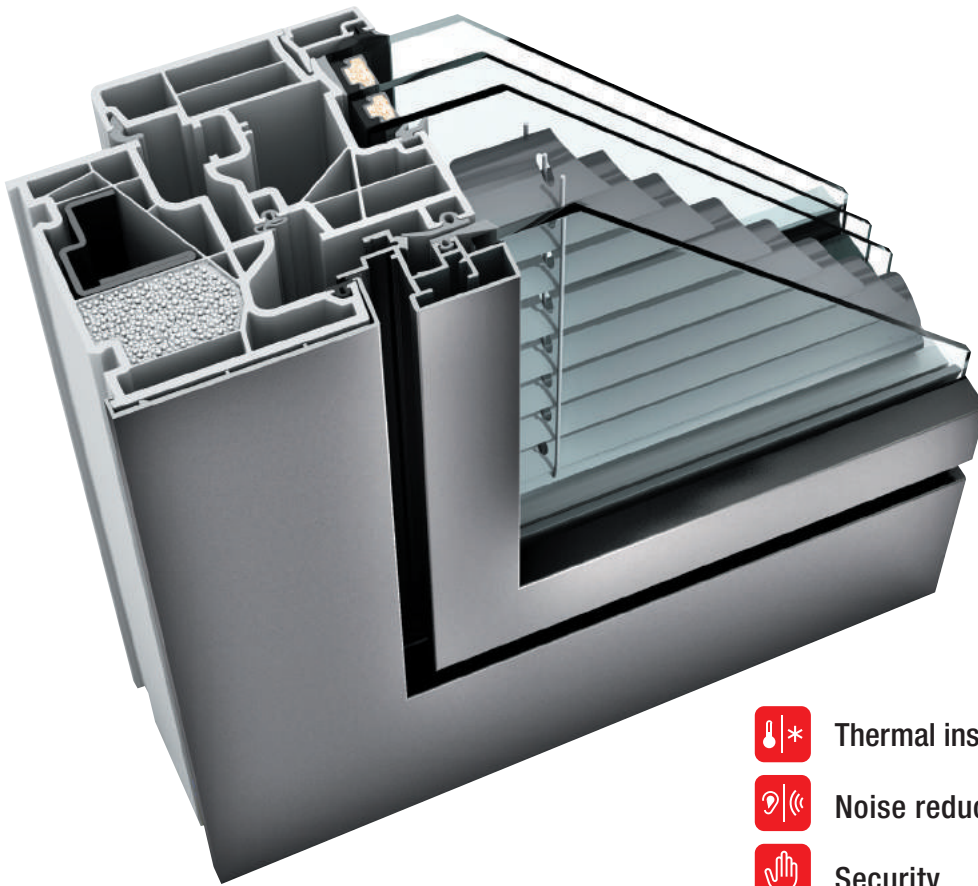

I-tec Glazing

I-tec Shading

I-tec Ventilation

I-tec Insulation

I-tec Connect

home soft

ambiente

home pure



**Thermal insulation**  $U_w$  as low as 0.64 W/(m<sup>2</sup>K)



**Noise reduction** up to 45 dB



**Security** up to RC1N, RC2



**Locking** concealed



**Construction depth** 93 mm

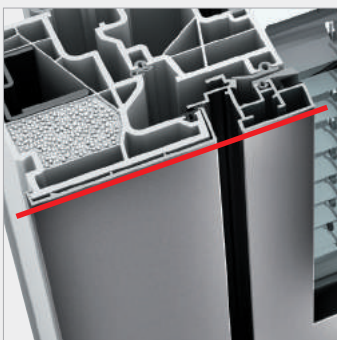

### KV 440

With the KV 440, the blind is fully integrated between accessible glass panes and is therefore protected from wind, rain and dirt, whilst still offering outstanding thermal performance with I-tec Insulation. Available with Venetian, Roman and Duette blinds in a selection of colours, the KV 440 offers privacy and sun protection, even for renovations or facades where roller shutters are not possible. The I-tec Shading option offers operation of the blinds via a photovoltaic module using solar energy, therefore not requiring an external power source.



# KV 350

## UPVC-ALUMINIUM WINDOW WITH INTEGRATED BLIND

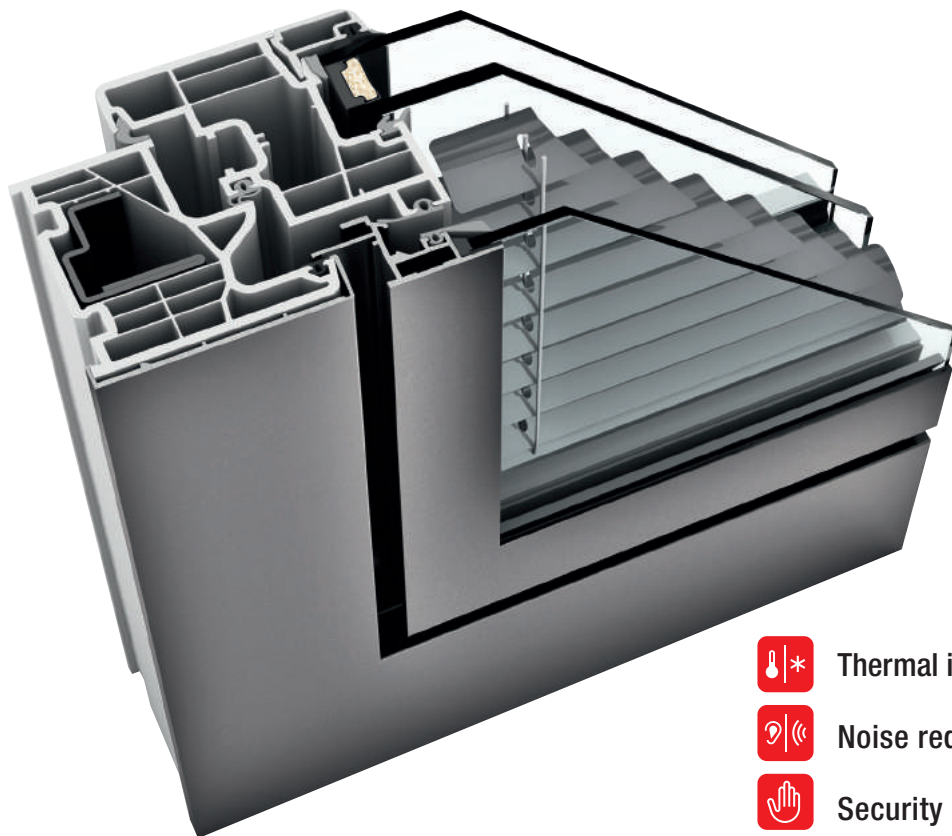





**I-tec** Glazing

**I-tec** Shading

**I-tec** Connect

ambiente

home pure

-  **Thermal insulation**  $U_w$  as low as 0.79 W/(m<sup>2</sup>K)
-  **Noise reduction** up to 44 dB
-  **Security** up to RC1N, RC2
-  **Locking** concealed
-  **Construction depth** 74 mm

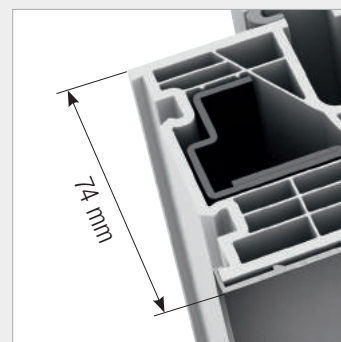
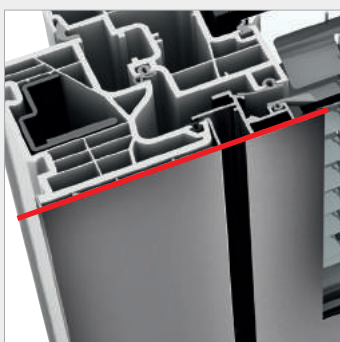

### KV 350

This stylish and slim window, with a construction depth of only 74mm, benefits from integrated, accessible blinds between glass panes. Providing sun protection and privacy, and available with different blind options, the KV 350 can be perfectly matched with the KF 310 uPVC-Aluminum window. The 6-chamber frame profile, combined with the I-tec Glazing, offers improved thermal performance, noise reduction, as well as protection from damp entering the cavities.



# KS 430

## UPVC & UPVC-ALUMINIUM LIFT & SLIDE DOOR



### NARROW

Narrow sliding frame and frameless elements with 3-sided rendering

### COMFORTABLE

Low threshold without obstruction

### SOFT

Soft handle closure as standard

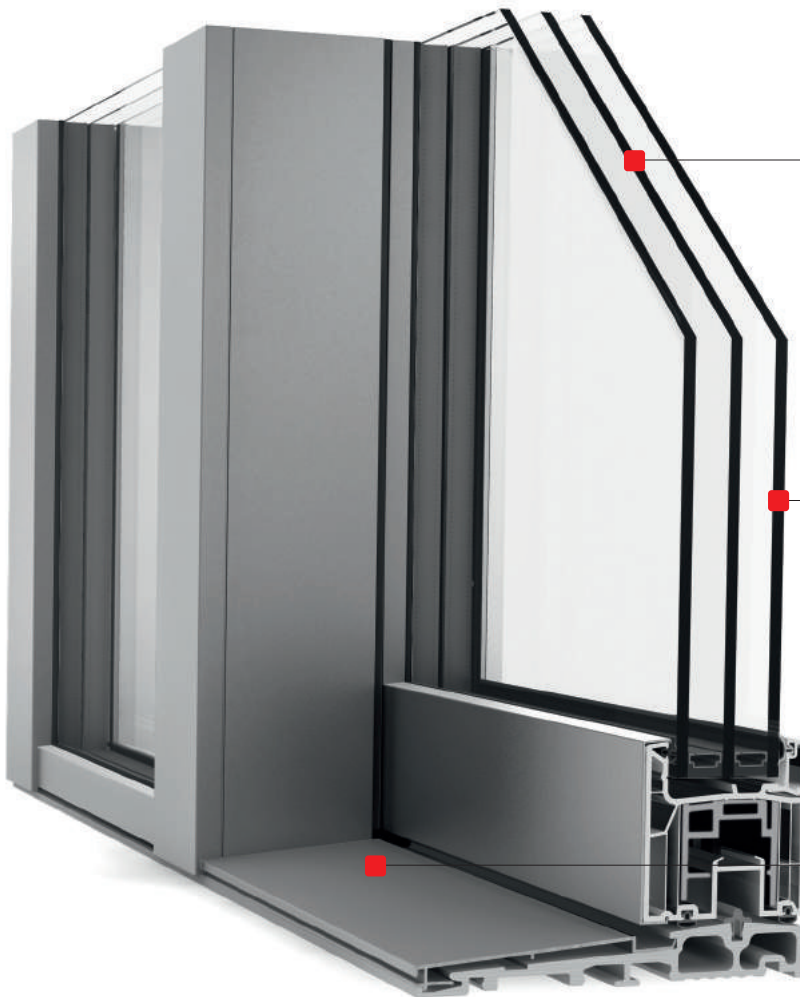

### I-tec Connect

More light from large glazing up to 650 x 280cm. Sash up to 400kg.

ESG toughened glass as standard to prevent injury.

The low threshold provides comfortable access and makes it suitable for barrier-free construction.



Comfort Drive allows your lift & slide door to be opened via electric operation. Can be integrated into a Smart Home system.



**Thermal insulation** up to  $U_w = 0.64 \text{ W}/(\text{m}^2\text{K})$



**Noise reduction** up to 43 dB



**Security** up to RC1N, RC2



*Create light and space  
with large Lift & Slide doors*

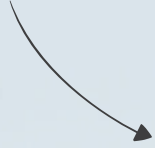







# TIMBER-ALUMINIUM

STYLISH. MODERN. SUSTAINABLE.









# HF 510

TIMBER-ALUMINIUM WINDOW

NEW



-  **Thermal insulation**  $U_w$  as low as 0.65 W/(m<sup>2</sup>K)
-  **Noise reduction** up to 43 dB
-  **Security** up to RC1N, RC2
-  **Locking** concealed
-  **Construction depth** 85 mm





*Rendering or over-cladding will achieve slim sightlines.*



**I-tec Core**  
**I-tec Glazing**

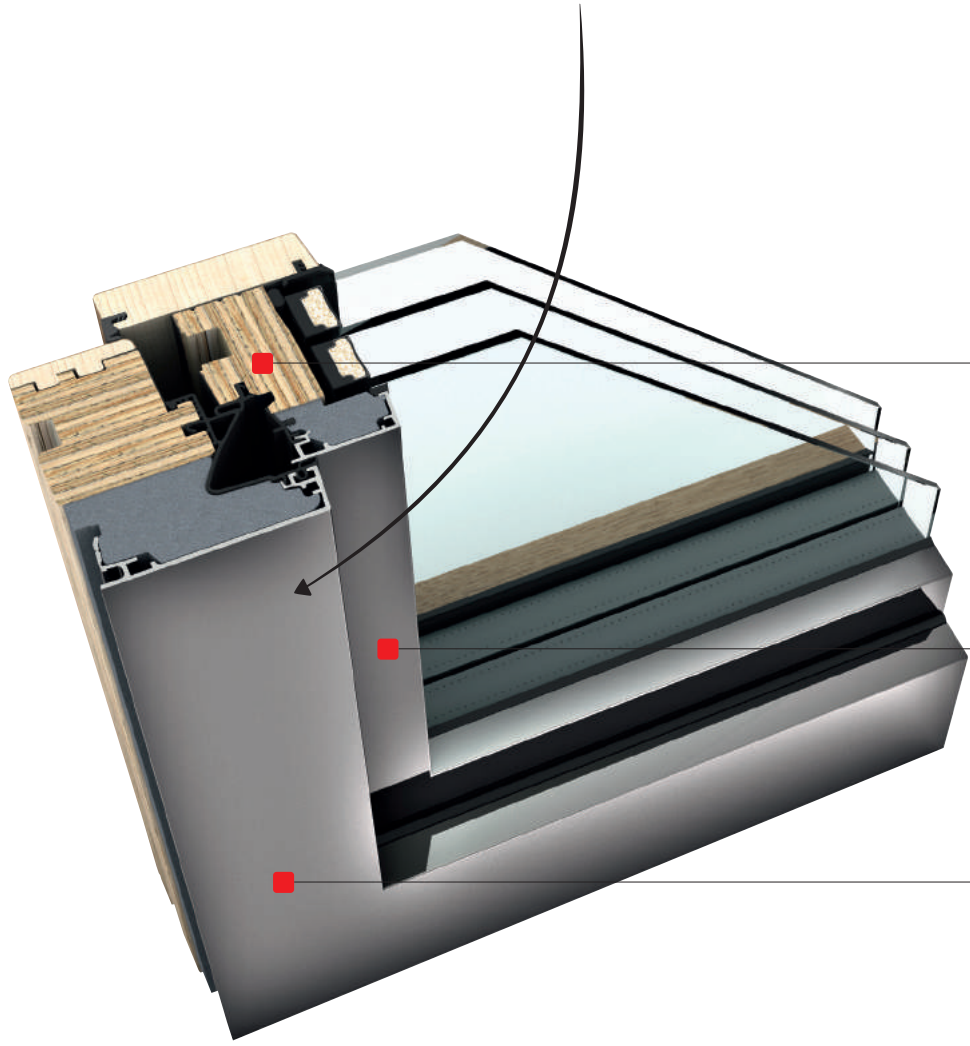

The I-tec Core makes this window exceptionally robust and stable, therefore making larger windows solutions possible. (I-tec Core pg. 43)

Slim, modern frame and even larger areas of glazing for increased light penetration and more comfortable living.

The square, linear features of the sash, frame make design style home pure the ideal window for modern architecture.

home pure

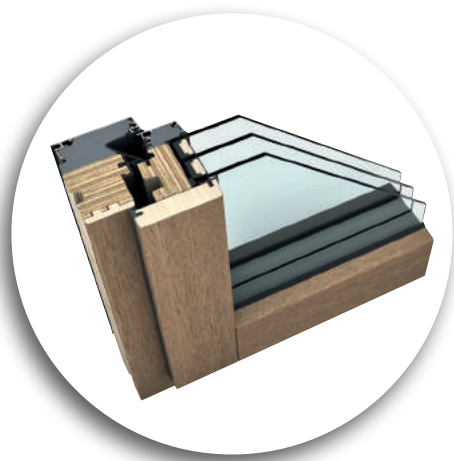

Internal View



I-tec Core



I-tec Glazing

# HF 410

## TIMBER-ALUMINIUM WINDOW

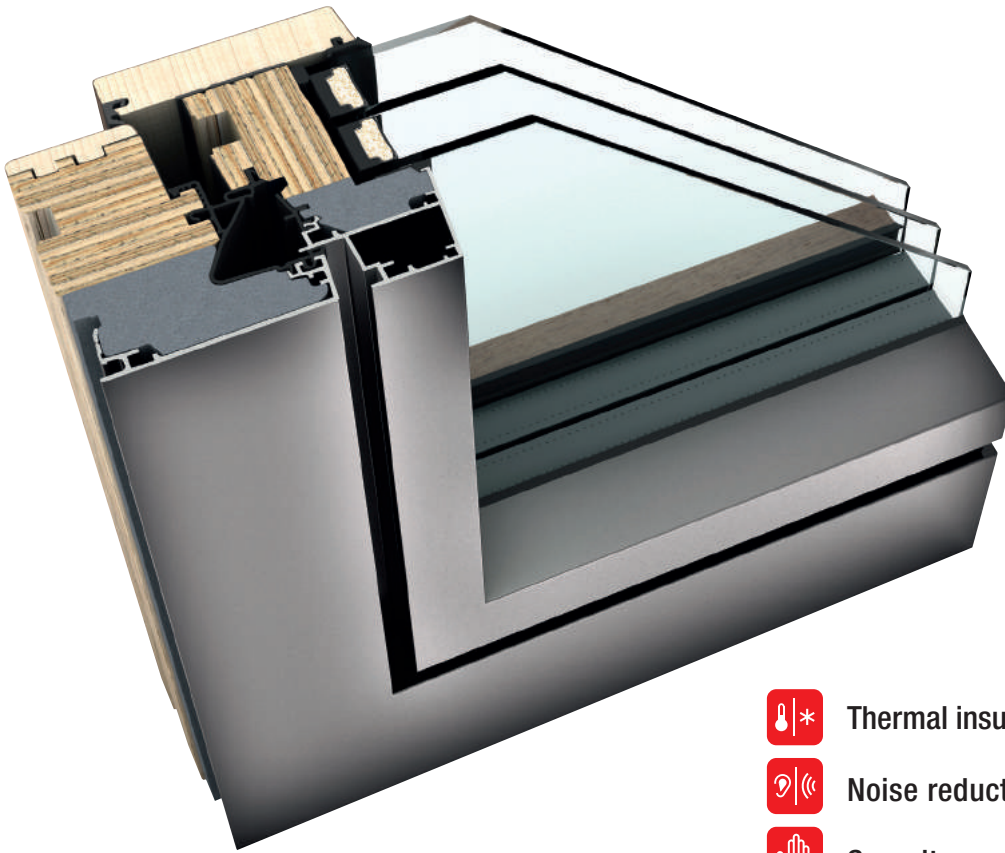





**I-tec** Core

**I-tec** Glazing

home pure

home soft

ambiente

-  **Thermal insulation**  $U_w$  as low as  $0.65 \text{ W}/(\text{m}^2\text{K})$
-  **Noise reduction** up to 45 dB
-  **Security** up to RC1N, RC2
-  **Locking** concealed
-  **Construction depth** 85 mm

studio



### HF 410

The unique I-tec Core technology of thin, laminated timber layers, makes the HF 410 exceptionally stable and robust, allowing the manufacture of even larger window sizes. The combination of timber, insulating foam and aluminium cladding provides superior thermal performance. Sustainably sourced timber options and a wide choice of colours offers unlimited interior design possibilities.



# HV 450

## TIMBER-ALUMINIUM WINDOW WITH INTEGRATED BLIND

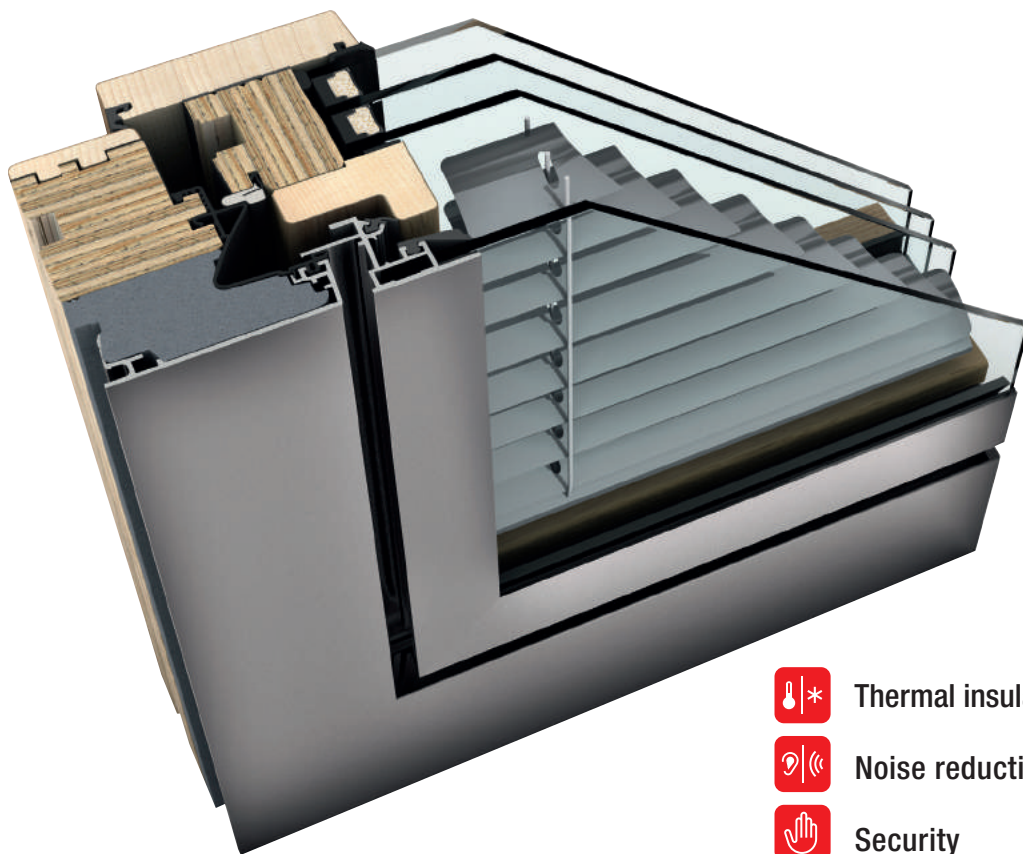

I-tec Glazing





I-tec Shading

I-tec Core

I-tec Connect

home soft  
ambiente

home pure

-  **Thermal insulation**  $U_w$  as low as 0.62 W/(m<sup>2</sup>K)
-  **Noise reduction** up to 46 dB
-  **Security** up to RC1N, RC2
-  **Locking** concealed
-  **Construction depth** 85 mm

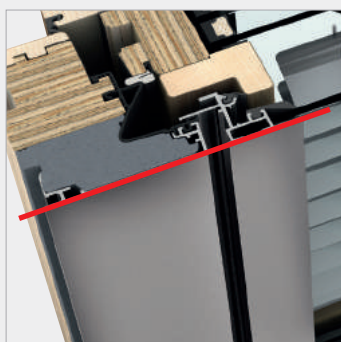

### HV 450

The thermally efficient HV 450, with blinds integrated between accessible glass panes, offers quadruple protection: sun, privacy, thermal and noise. With a choice of styles and colours, the integrated blinds are protected from wind, rain and dirt. The I-tec Shading solution offers operation of the blinds via a photovoltaic module using solar energy, therefore not requiring an external power source. Also available as hard wired or manual operation. Internorm shading options can be integrated into a Smart Home system.







# HS 330

## TIMBER-ALUMINIUM LIFT & SLIDE DOOR



### ENERGY-EFFICIENT

Fibreglass threshold for optimum thermal insulation

### FRAMELESS

Frameless glazing achieved with fully rendered fixed elements

### COMFORTABLE

Easy to lift and slide up to 400kg sash weight



**I-tec Glazing**

**I-tec Connect**

Can be combined with fixed glazing for even large glazed areas.

Stylish external colour options – can be perfectly combined with the timber-aluminium windows HF 410, HF 510 and HV 450.

Energy-saving, low fibreglass threshold for optimal thermal insulation and stability.



**Comfort Drive** allows your lift & slide door to be opened via electric operation. Can be integrated into a Smart Home system.



**Thermal insulation** up to  $U_w = 0.73 \text{ W}/(\text{m}^2\text{K})$



**Noise reduction** up to 40 dB



**Security** up to RC1N, RC2

# HX 300

## PANORAMA



### OPEN

Glass joint virtually invisible

### BRIGHT

Large glazing up to 10.5m<sup>2</sup>

### FRAMELESS

Frame almost entirely disappears into the facade.



**Thermal insulation** up to  $U_w = 0.74 \text{ W}/(\text{m}^2\text{K})$



**Noise reduction** up to 47 dB



Create visual features with integrated windows

Triple safety glass for optimal thermal insulation

Strong, glued multi-layered frame construction

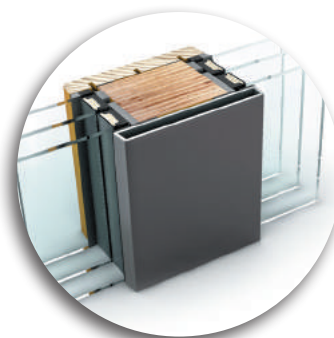
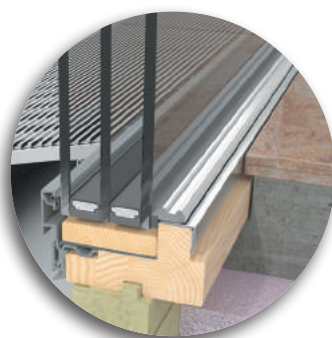
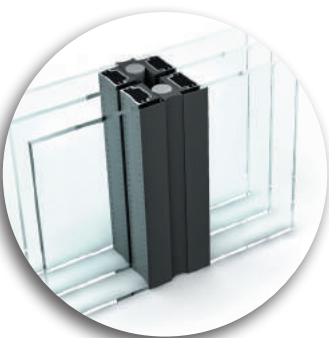



*Why not add a glass-to-glass corner for uninterrupted views?*



## uPVC

NEW

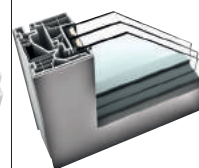
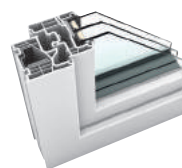
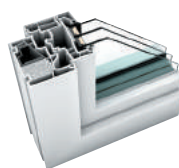
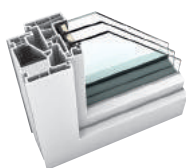
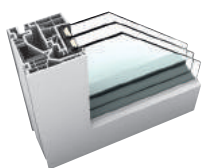

**KF 520**

**KF 510**

**KF 410**

**KF 310**

**KF 520**

### Thermal Insulation in W/(m<sup>2</sup>K)

ECLAZ® Coating

$U_w = 0.70$

$U_w = 0.71$

$U_w = 0.71$

$U_w = 0.76$

$U_w = 0.70$

Best Value

$U_w = 0.63$

$U_w = 0.63$

$U_w = 0.62$

$U_w = 0.69$

$U_w = 0.63$

### Noise Insulation (dB)

33 – 46

34 – 46

34 – 47

33 – 45

33 – 46

### Security

RC2, RC3

RC2, RC3

RC1N, RC2

RC1N, RC2

RC2, RC3

### Locking

fully integrated

fully integrated

concealed

concealed

fully integrated

### Dimensions in mm

Frame Construction Depth

90

90

90

71

93

Sightline frame/sash

85

95

113

107

85

Sightline flying mullion (2 sashes)

96

100

133

119

96

Sightline mullion (2 sashes)

148

147

187

170

148

### Design

Fixed

X

X

X

X

X

Turn and Tilt/Turn

X

X

X

X

X

Tilt

X

X

X

X

X

Parallel sliding window

X

X

X

Lockable door

X

X

X

Lift & Slide door

X

X

X

Doors with low threshold

X

X

X

X

X

Outward opening doors

X

X

### Gasket

Number

3

3

3

3

3

Colour external gasket

light grey

light grey

light grey

light grey

light grey/black

### Georgian Bars stick-on and internal

in different widths

home soft

home soft

in different widths as well as gold and lead bars

ambiente

ambiente

### Available in Design Styles

studio

home pure

home pure

home soft

home soft

ambiente

ambiente

studio

### Further information on pages

10

11

12

13

10



uPVC-ALUMINIUM

TIMBER-ALUMINIUM

NEW					NEW		
KF 510	KF 410	KF 310	KV 440	KV 350	HF 510	HF 410	HV 450
$U_w = 0.72$	$U_w = 0.71$	$U_w = 0.76$	$U_w = 0.78$	$U_w = 1.1$	$U_w = 0.72$	$U_w = 0.71$	$U_w = 0.97$
$U_w = 0.64$	$U_w = 0.62$	$U_w = 0.69$	$U_w = 0.64$	$U_w = 0.79$	$U_w = 0.65$	$U_w = 0.65$	$U_w = 0.62$
34 – 46	34 – 47	33 – 45	39 – 45	38 – 44	35 – 44	33 – 45	41 – 46
RC2, RC3	RC1N, RC2	RC1N, RC2	RC1N, RC2	RC1N, RC2	RC1N, RC2	RC1N, RC2	RC1N, RC2
fully integrated	concealed	concealed	concealed	concealed	concealed	concealed	concealed
93	93	74	93	74	85	85	85
95	113	107	118	112	99	108	108
100	133	119	144	130	106	124	124
147	187	170	198	181	156	173	173
x	x	x			x	x	
x	x	x	x	x	x	x	x
x	x	x	x	x	x	x	x
x	x	x			x	x	
x	x	x			x	x	
x	x	x	x	x	x	x	x
	x	x				x	
3	3	3	3	3	3	3	3
light grey/ black	light grey/ black	light grey/ black	light grey/ black	light grey/ black	black	black	black
	home soft ambiente	home soft ambiente	home soft ambiente	ambiente		home soft ambiente	home soft ambiente
	studio					studio	
home pure	home pure	home pure	home pure	home pure	home pure	home pure	home pure
	home soft	home soft	home soft			home soft	home soft
	ambiente	ambiente	ambiente	ambiente		ambiente	ambiente
11	12	13	14	15	20	22	23





*Watch video of case study*





# Renovations...

TRANSFORM YOUR HOME WITH  
INTERNORM TRIPLE GLAZING

This period property is a fantastic example of Internorm windows and doors being integrated into more traditional architecture. The original section of this stunning property in Hertfordshire was built in 1904 and extended over time. The previous golden oak uPVC double-glazed windows were replaced by Internorm triple-glazed Timber-Aluminium windows and French doors. The old uPVC bi-fold doors at the rear stopped functioning fully and the vertical bars took a lot of the light away from the kitchen area and the old bi-fold doors were replaced by our large lift & slide doors, which instantly brightened the interior and made a huge difference to the home.

With its integrated Georgian bars, the Internorm composite windows look like the originals from over 100 years ago but with the benefits of superior technical performance you get from Internorm products. As this property is situated near a busy road, the triple glazing made an enormous difference to the noise reduction and together with the I-tec Glazing dramatically improved the security of the property. The homeowner was delighted:

*"Having recently had our windows and bifold doors replaced throughout our property with Internorm triple glazed units, any doubts about the value for money have gone entirely, now that I've experienced the product installed. Aesthetically the windows have transformed our property, but there are so many other benefits. I put a premium on security, and these are second to none. We enjoy more light into rooms with large expanses of glass and less obtrusive frames than we had before and the improvement in sound insulation – from relatively new double glazed uPVC units previously – is well beyond anything I expected."*

**Products installed:** Timber-Aluminium HF 410 windows + French doors, HS 330 Lift & Slide Doors with Georgian bars.

**Colours:** Interior timber factory painted in Traffic White RAL9016. Exterior aluminium cladding in Jet Black RAL9005.

Speak to your local Internorm partner to see how your home can be transformed.



# PERFECT COMBINATIONS

TRUE TO STYLE. INDEPENDENT OF MATERIALS. MATCHING.

Individual architecture increases the demand on window design, energy efficiency and comfort. With Internorm, functionality and design are not a contradiction. It is possible to perfectly mix and match uPVC-aluminium and timber-aluminium in one project.

## **Same design on the outside – choose between uPVC and timber on the inside**

If you prefer a uPVC-aluminium window in the bathroom due to high humidity, but prefer the feel and look of a timber-aluminium window in the living room – no problem. The design style and exterior finish of your windows will look and remain the same. The difference is on the inside where you can choose between classic uPVC or natural timber.

## **Consistent architectural style throughout**

No matter what design style you choose for your home - avant-garde, contemporary, traditional or timeless – Internorm offers you the perfect solution for combining materials and products to suit your particular need.

## **Combine with lift & slide doors**

To ensure that you don't miss out on large scale glazing and more light in your home, you can even choose your lift & slide doors in uPVC-aluminium and timber-aluminium to match your windows to achieve a uniform look.





## OUTSIDE – THE SAME



### Aluminium

The aluminium cladding on the outside matches the design style of your house.

## INSIDE – YOUR CHOICE



### uPVC

uPVC is longlasting, maintenance free and perfect for rooms with high humidity, e.g. bathrooms.



### Timber

Timber has a natural, warm feel and is ideal for living spaces and bedrooms.



# JULIET BALCONY

EVEN SMALLER ROOMS FEEL MORE SPACIOUS.

Balconies and terraces are no longer as popular as they once were and often not an option in city centres for structural reasons. However, large glass areas are integral to modern architecture.

Juliet balconies are the perfect solution for letting more light into a room, providing uninterrupted views, and creating beautiful design features. Made with laminated safety glass and stainless steel trim, Internorm's Juliet balconies are uniquely integrated into the door frame and factory fitted.

*Please ensure that minimum heights comply with Building Regulations to prevent falling.*





Juliet balcony options



Option with laminated safety glass balustrade, including stainless steel trim



Option with round stainless steel rail



Option with square stainless steel rail



# SUN AND INSECT PROTECTION

MIX & MATCH. INTEGRATED. MANY VARIATIONS.

Sun and insect protection can be combined with the window systems to provide added functionality and to enhance the facade of your house. They can also be integrated into your Smart Home system and conveniently controlled from your smartphone or tablet.

**Integrated blinds:** Sun and privacy protection integrated between glass panes. Choose from Roman, Venetian or black-out Duette blinds, also available with solar powered I-tec shading.

**Internal blinds:** Mounted on the window sash, it can be colour matched to the internal window frame.

**Raffstores:** Optimum control of light and solar gain with adjustable slats. Optional RETROLux louvres. Can be combined with fly screen. Ideal for lift & slide doors.

**Internal Venetian blinds:** Optimum control and guidance of light and warmth through adjustable slats. Can be combined with insect protection.

**External roller/mini-roller shutters:** Delivered separately or fitted to window. Can be combined with fly screen.

**Fly screens:** Available with friction-fit, turn or sliding frames, or pull-down roller mechanism. Can be combined with sun protection options.

**Pleated fly screen:** Space-saving and perfect retrofit solution, suitable for lift & slide doors.

**Window shutters:** Made from aluminium, available in many designs. Can be combined with fly screen.





Raffstores



**I-tec** Shading  
Integrated blind



Internal blind



External roller shutter



Mini exposed roller shutter



Pull-down fly screen



Turn or fixed frame



Sliding frame



Pleated fly screen



# RAFFSTORE EXTERNAL BLINDS

AVOID OVERHEATING. REDUCE COSTS.

Did you know that smart controlled raffstores can reduce room temperature in summer by up to 10°C compared to unshaded rooms?

Particularly on south-facing rooms it is important to include shading to large areas of glazing to avoid overheating during the summer months. Modern raffstore systems can be integrated into Smart Home systems and help to control solar radiation and light transmission, therefore contributing to passive cooling in summer and solar heating in winter.

## **Up to 50% less cooling energy**

Did you know that cooling a room by 1°C with air conditioning uses three times more energy than increasing heating by 1°C.

## **Up to 30% less energy consumption**

Smart controlled raffstores considerably reduce energy consumption by passive cooling and solar heating.

## **Reduce electricity costs by up to 80% by not using artificial lighting**

Raffstore allow you to control the amount of sun entering your home and the specially designed slats effectively direct daylight into the interior.

## **Up to 8.5 tonnes of CO<sub>2</sub> saved**

One raffstore can save about 8.5 tonnes of CO<sub>2</sub> in its lifetime. The manufacture, use and disposal of a raffstore only creates around 150kg of CO<sub>2</sub>.









## RAFFSTORE

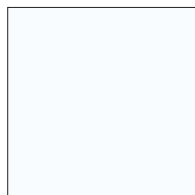

RAL 9016  
Traffic white



RAL 1015  
Light ivory



Light beige

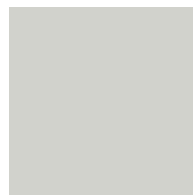

RAL 7047  
Telegrey



RAL 6005  
Moss green



RAL 7038  
Agate grey



RAL 9006  
White aluminium

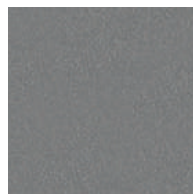

RAL 9007  
Grey aluminium

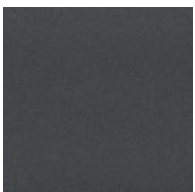

DB 703



RAL 7016  
Anthracite grey

## ROLLER SHUTTERS



white

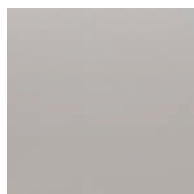

grey



creme

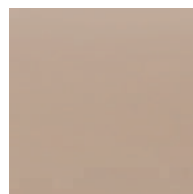

beige

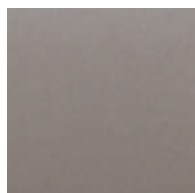

Grey aluminium

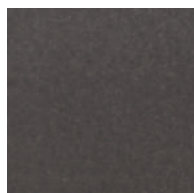

DB703 aluminium-grey



aluminium-anthracite  
grey

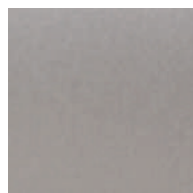

aluminium-natural



aluminium-wood dark

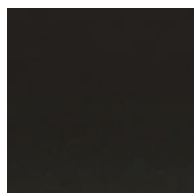

aluminium-brown

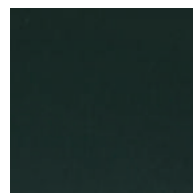













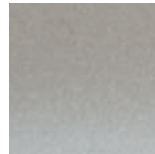
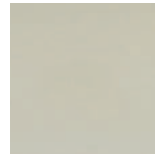



aluminium-moos green







## INTEGRATED & INTERNAL BLINDS (VENETIAN)

							
0205 milk	0152 crystal	0605 sapphire	0958 moonstone	7010 silver	7113 aluminium	4448 cream	4449 cortina
							
5056 burgundy red	4808 topaz	4768 praline	4161 messina	4049 genua	4249 torino	2236 indigo	2371 gentian blue
							
3763 fern green	3251 fir						

## DUETTE®

						
2340 cloud	2342 dolphin grey	2345 fog	2341 winter white	2346 oyster	2327 dark blue	2337 royal red

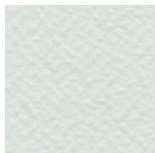
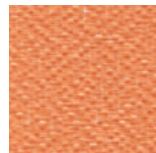
## ROMAN BLINDS

							
E001 white	E819 cream	E901 beige	E800 yellow	E802 orange	E812 may green	E811 light blue	E816 grey

# I-TEC INNOVATIONS

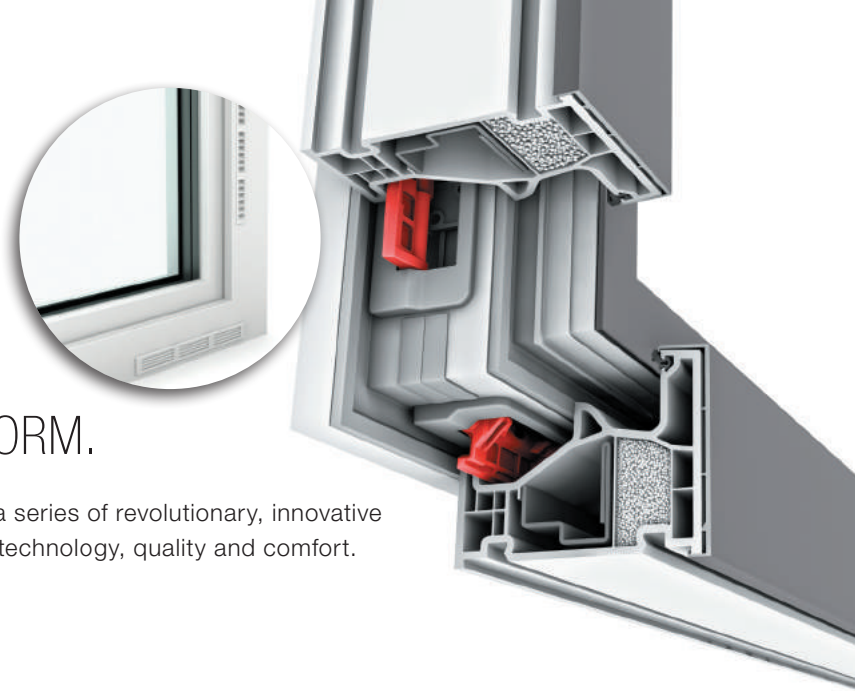

## NEW STANDARDS FROM INTERNORM.

Under the heading **I-tec**, Internorm has been developing a series of revolutionary, innovative technologies to meet the increasing demands on design, technology, quality and comfort.

- **I-tec Secure**
- **I-tec Glazing**
- **I-tec Core**
- **I-tec Insulation**
- **I-tec Shading**
- **I-tec Connect**

Discover Internorm's innovative technologies and find out why I-tec is so unique.

## **I-tec** Secure

### FEEL SAFE

UNRIVALLED, FULLY INTEGRATED  
LOCKING UP TO RC3

#### ADVANTAGES

- Enhanced security up to RC3 available, achievable with integrated flaps
- Levering of window is practically impossible
- Clean look as locking hardware is concealed
- Easy to clean window frame
- Modern glass architecture with slim sightlines

Feeling safe and secure in your home is paramount. The unrivalled I-tec Secure locking system ensures that your windows provide reliable protection. The customary locking pegs are replaced by flaps that securely lock the window sash to the frame, making levering of the window practically impossible. The concealed hardware makes cleaning the windows easier.

**I-tec Secure is integrated into the new KF 510 and KF 520 uPVC and uPVC-Aluminium systems.** It can reach security class RC2N with an optional lockable handle and is available up to security class RC3 on request.



Discover more about I-tec Secure  
[uk.internorm.com/i-tec-innovations/i-tec-secure/](http://uk.internorm.com/i-tec-innovations/i-tec-secure/)





## I-tec Core

# STRENGTH AND STABILITY

## WIDE SELECTION OF TIMBER OPTIONS

### ADVANTAGES

- Highly stable core in window frame and sash
- Slim sightlines for more light
- Match timber types and colours to your interior – large choice of colours and timbers
- Attractive price-performance ratio
- Option to match windows and lift & slide doors.

With I-tec Core, Internorm windows are able to achieve high stability and strength. The thin laminated layers of timber

are exceptionally resistant, durable and strong, enabling the manufacture of large windows and lift & slide doors. This high-tech material is sustainable, and due to its strength, suitable for large dimensions. The wide choice of timber, such as spruce, larch, oak, ash and walnut, used on the inside of our windows and lift & slide doors, can be matched to your individual interior decoration, furniture, flooring and doors.



Discover more about I-tec Core  
[uk.internorm.com/i-tec-innovations/i-tec-core/](http://uk.internorm.com/i-tec-innovations/i-tec-core/)

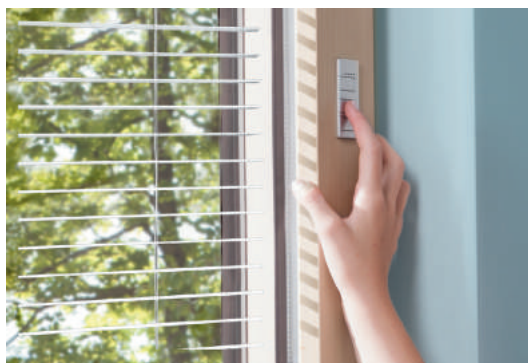

Discover more about the  
 I-tec Shading.  
[uk.internorm.com/i-tec-innovations/i-tec-shading/](http://uk.internorm.com/i-tec-innovations/i-tec-shading/)

## I-tec Shading

# SOLAR POWERED

## SELF-SUFFICIENT SUN PROTECTION

### ADVANTAGES

- No electricity needed due to the photovoltaic module
- Use of energy gain in winter – reduction of heating costs
- Automatic functions such as day/night recognition and measuring of solar irradiation
- Manual control available directly at the window frame
- Convenient control also available via Smart Home solutions
- Photovoltaic module and sun protection integrated between glass panes

The clever I-tec Shading is the perfect solution for adding sun protection and privacy and to stop overheating. The energy required to operate the integrated blind is generated by a photovoltaic module or solar panel. No hard wiring is necessary as the unit is totally self contained within the window. Available as Venetian, Roman or Duette option, the blind can be operated via a remote control or integrated into a Smart Home system. Available with KV and HV window systems.

**I-tec Glazing**

**I-tec Insulation**

# CONTINUOUSLY EFFICIENT

## SAFETY ALL AROUND

### ADVANTAGES

#### I-TEC GLAZING

- Maximum burglary protection
- Increased stability
- Increased thermal insulation
- Improved noise reduction

#### I-TEC INSULATION

- Granulate instead of foam
- Improved thermal insulation
- Hollow chambers filled on all sides

To ensure maximum security, Internorm windows are fitted with **I-tec Glazing** as standard. This technology means that glass panes are glued to the sash all the way round. This considerably improves stability, thermal insulation, noise reduction and burglary protection.

**I-tec Insulation** is standard for three Internorm window systems: KF 410, KF 510 and KV 440. A granulate is pushed into the hollow chambers under pressure and therefore completely fills them all the way round. I-tec Insulation provides considerable improvement in thermal insulation.

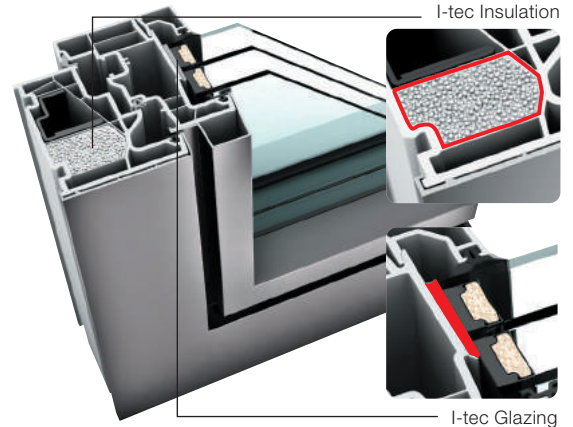

Discover more about these I-tec innovations.  
[uk.internorm.com/i-tec-innovations/i-tec-glazing/](http://uk.internorm.com/i-tec-innovations/i-tec-glazing/)



**I-tec Connect**

# SMART HOME READY

## CONTROL AT YOUR FINGERTIPS

### ADVANTAGES

- Intelligent control around the window
- Mobile operation of I-tec Ventilation, I-tec Shading, and fanlights
- Opening monitoring of your windows
- Direct integration into central SmartHome solutions

Whether you are at home or on the road, intelligent automation allows you to control heating, lighting, audio, security, shading, and much more.

I-tec Connect offers a range of intelligent window products that can be integrated into a Smart Home system. Window opening monitoring, I-tec Ventilation, I-tec Shading, blinds or fanlights can be operated via an app on your smartphone or tablet. A simple finger tap will open or close blinds, adjust the light control or regulate the airflow of the ventilation. Even the electric Comfort Drive on a lift & slide door can be connected to your home network via your Wifi hub.



Discover more about I-tec Connect.  
[uk.internorm.com/i-tec-innovations/i-tec-connect/](http://uk.internorm.com/i-tec-innovations/i-tec-connect/)





# ECLAZ® THE PREMIUM GLASS COATING

## NOW IN EVERY INTERNORM WINDOW

Unlike artificial light, sunlight does not just create a brighter environment, the colour spectrum also has positive and uplifting biological and psychological effects that can impact your health and wellbeing of humans.

### Improve natural daylight transmission with ECLAZ® premium glass coating

To allow even more natural light to flood your home, Internorm offers the premium ECLAZ® glass coating as standard across its whole product range.

## COMPARED TO CONVENTIONAL GLASS, ECLAZ® OFFERS:



#### More light & transparency

- The special coating allows more daylight to enter the interior, therefore making it brighter and friendlier.
- Enjoy a clearer view of the outside. The external reflection or mirror effect is also low and the glass is colour-neutral from the outside.



#### Improved health & productivity

- ECLAZ® helps to regulate your inner balance. Blue light from the sun helps to regulate your natural sleep and wake cycle, elevate moods and increase the feeling of well being.
- It also helps to boost alertness, improve productivity and learning.



#### Increased happiness & well-being

- Daylight has a balanced light spectrum and regulates the serotonin balance, which is responsible for well-being and life energy. Halogen bulbs, fluorescent tubes and LEDs lack these important light frequencies. ECLAZ® floods the house with daylight.
- 77% more light transmission of triple glazing with ECLAZ® helps to boost health and well-being, especially in the darker autumn and winter months.



#### Better energy efficiency & higher cost savings

- Less heat loss: ECLAZ® provides excellent thermal insulation, therefore reducing heating costs.
- Greater energy savings: 60% improvement in solar gain with triple glazing resulting in lower heating costs and higher energy efficiency.



#### Get more as standard

- ECLAZ® is fitted as standard in every Internorm window.
- No additional costs. You enjoy the benefits of this premium glass coating without having to pay more.



# FEEL SAFE AND SECURE

RELIABLE. EFFECTIVE. PATENTED.

To feel safe and secure in your own home, burglary protection as well as maximum security for children are fundamental requirements. Quality windows largely contribute to this feeling of safety and with the proven technologies from Internorm, you can protect your family and make it difficult for intruders to enter your home.





### Security locking elements

All Internorm window systems are equipped with standard security hardware. Solid, yet discreet silver designer locking elements, together with octagonal mushroom cams in the frame, provide secure locking (except KF 510 and KF 520).



### I-tec Secure (KF 510 and KF 520)

Internorm's revolutionary locking technology guarantees maximum protection. When locking the window, flaps open and press into the frame on all sides, making it virtually impossible to lever the window.



### Security handle

The new Secustik® window handle contain a jamming-device which provides integrated security. This makes it more difficult to move the window fitting unlawfully from outside. (standard on KF 510 and KF 520 uPVC and uPVC-aluminium windows).



### Lockable handles

Lockable handles offer optimal security for use by children as well as burglary protection. The window is locked with a key and cannot be opened from the inside or outside.



### Concealed hardware

Concealed hardware prevents windows from being levered out of their hinges, with the added benefit of making windows look neat and easy to clean.

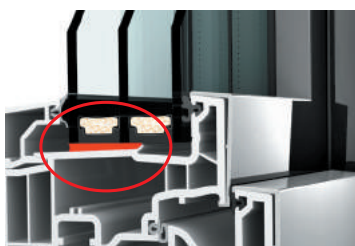

### I-tec Glazing

Thanks to Internorm's patented glazing technology, the glass pane cannot be pushed out. The glass is glued into the frame all the way round, making it more secure and stable. Most Internorm window systems include this I-tec innovation as standard.



### Electronic opening detector

Discreet and reliable, these hard wired or wireless locking sensors report whether windows or French doors are open, tilted or locked.









### Laminated glass

Unlike standard glass, laminated glass does not shatter when broken. A tough interlayer bonded between two glass panes ensures that the glass stays in the frame and does not cause injury.



## INTERNORM HANDLE COLOURS

-  F1 Aluminium natural
-  F9 aluminium steel
-  RAL910 white
-  F9714m black matt
-  Brass polished
-  Chrome satin finish
-  Chrome/stainless steel matt
-  Brass matt/aluminium steel

# WINDOW HANDLES

## OUR ENTIRE RANGE AT A GLANCE

The Internorm window handles fit comfortably into your hand and are available as round, square or flat option. We recommend matching the window handles to your existing interior doors and furniture.



**Lift & slide door handle  
G80**  
III. in black matt  
Item no. 36133

available in the colours



**Lift & slide door handle  
Dallas**  
III. in aluminium natural  
Item no. 36424

available in the colours



**Lift & slide door handle  
Softline**  
III. in aluminium natural  
Item no. 32447

available in the colours



NOTE: Not all handle options are available for each window system. Your Internorm distribution partner will be happy to advise you on the possible combinations.





**Handle G80 flat cylinder key hole cover plate III. in aluminium natural**  
Item no. 36435

available in the colours



**Handle G80 III. in aluminium natural**  
Item no. 36404 (item no. 36505 for KF310/KF320/KV350)

available in the colours



**Handle G80 lockable III. in aluminium natural**  
Item no. 36400

available in the colours



**Handle G80 with push button III. in aluminium steel**  
Item no. 36394

available in the colours



**Secustik® handle G80 III. in aluminium natural**  
Item no. 36428

available in the colours



**Secustik® handle Austin flat cylinder key hole cover plate III. in black matt**  
Item no. 36170

available in the colours



**SecuForte® III. in black matt**  
Item no. 36132

available in the colours



**Secustik® handle Dallas III. in aluminium natural**  
Item no. 36426

available in the colours



**Standard handle III. in aluminium natural**  
Item no. 33899  
(item no. 36504 for KF310/KV350)

available in the colours



**Handle with push button III. in aluminium natural**  
Item no. 33885

available in the colours



**Designer handle Bruxelles III. with chrome satin finish**  
Item no. 34592

available in the colours



**Handle Amsterdam III. in aluminium natural**  
Item no. 36416

available in the colours



**Designer handle Athanai III. in brass matt/aluminium steel**  
Item no. 34594

available in the colours



**Handle lockable III. in brass**  
Item no. 33886

available in the colours



**Designer handle Atlanta III. in brass**  
Item no. 34750

available in the colours



# COLOURS

## INTERNAL WINDOW OPTIONS

### uPVC

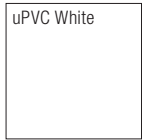

DECOR FOILS	KF 520	KF 510	KF 310	KV 350	KF 410 studio	KF 410 home p.	KF 410 home s.	KF 410 ambiente	KV 440 home p.	KV 440 home s.	KV 440 ambiente	KS 430
Golden Oak			X	X			X	X		X	X	X
Brilliant White			X	X	X	X	X	X	X	X	X	X
Cream White			X	X			X	X		X	X	X
Dark Grey	X	X	X	X	X	X			X			X

### Timber

standard colour **SPRUCE**, varnished  
 HF 410/510 HV 450 HS 330

FI500	X	X	X
FI501	X	X	X
FI502	X	X	X
FI503	X	X	X
FI505	X	X	X
FI506			X
FI507			X

standard colour **SPRUCE**, varnished  
 HF 410/510 HV 450 HS 330

FI508			X
FI509			X
FI510	X	X	X

standard colour **SPRUCE**, opaque  
 HF 410/510 HV 450 HS 330

FI916	X	X	X
-------	---	---	---

Standard colour **LARCH**, varnished  
 HF 410/510 HV 450 HS 330

LA600	X	X	X
LA604 oiled	X	X	X

**OAK**  
 HF 410/510 HV 450 HS 330

EI700	X	X	X
EI701	X	X	X
EI706 oiled	X	X	X
EI707 oiled	X	X	X

**ASH**  
 HF 410/510 HV 450 HS 330

ES800	X	X	X
-------	---	---	---

**WALNUT**  
 HF 410/510 HV 450 HS 330

NU400	X	X	X
-------	---	---	---



# EXTERNAL WINDOW OPTIONS

## uPVC

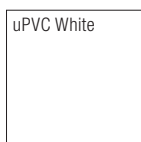

Please note that not every colour is available for every window.

Due to printing and manufacturing technology colour deviations between illustrations and original products may occur.

Your Internorm partner will be happy to show you original colour samples.

## Aluminium cladding

### STANDARD COLOURS\*



### hiRest-COLOURS\*\*\*



### HDS COLOURS\*\*



### STAINLESS STEEL COLOURS

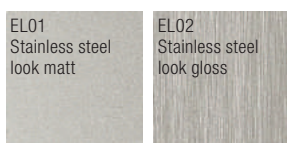

- \* **Highly weather-resistant**, except M916 (facade quality).
- \*\* Intensive colour, variation possible.
- \*\*\* For surface options **HM** (highly weather-resistant standard colour), **HF** (highly weather-resistant fine structure), **HFM** (highly weather-resistant fine structure metallic), a special highly weather-resistant powder coating is used.

*Please note*

SPECIAL COLOURS

The Internorm RAL colour range (facade quality) offers even more options. These colours are available for external aluminium cladding and internal timber.







# ENTRANCE DOORS

BESPOKE AND INDIVIDUAL



## Make a statement with a stylish entrance

Each Internorm entrance door is created to your individual requirements. Choose from different designs, colours, finishes, handles and glass options. You can even add a fingerprint scanner and link your entrance door to your Smart Home system - the choice is yours.

To make it even easier for you to decide on the perfect door for your home, use our great **Door Designer** tool on our website - simply scan the QR code below and get creative! You can upload an image of the front of your house and design your Internorm entrance door to suit any architectural style.

Your local Internorm partner will also be happy to assist.



Discover more about Door Designer.  
[uk.internorm.com/](http://uk.internorm.com/)  
[internorm-door-designer/](http://internorm-door-designer/)



# SERIES.F

## FLUSH & LINEAR

Solid flush doors keep your home private. Create your own minimalist entrance door with discreet groove milling and trims. A choice of straight or recessed handles will add to the overall design to create an impressive and modern entrance area.







**FG**

Colour: HFM14  
Handle: EGS01  
Order no: F0003

- AT 540
- AT 530
- AT 520
- AT 500
- HT 410**
- HT 400



**FJ**

Colour: Frame RAL 9005  
Sash: SD05 Art-Corten  
Handle: KGS04  
Decor: Alu trim  
Order no: F004

- AT 540
- AT 530**
- AT 520
- AT 500
- HT 410
- HT 400

Real wood in antique finish -  
each door is unique.



## FO

Colour: HFM05  
Handle: RGS01  
Decorative strip: Alunox 20mm  
Order no: F0005

AT 540 AT 530 AT 520 AT 500 HT 410 HT 400



## FD

Colour: Frame HM716  
Sash: SD10, HM716  
Handle: RGS05  
Special glass: Dark Grey  
Order no: F0002

AT 540 AT 530 AT 520 AT 500 HT 410 HT 400





**FP**

Colour: Frame HM704,  
Sash HM704, M916  
Handle: KGS03  
Order no: F0006

- AT 540
- AT 530
- AT 520
- AT 500
- HT 410
- HT 400



**FU**

Colour: Frame HM716  
Sash: HM712  
Handle: SG13  
Order no: F0010

- AT 540
- AT 530
- AT 520
- AT 500

Black as well as stainless steel coloured trim give these doors a very special look.



## FT

Colour: Frame RAL9005  
Sash: SD09 Art-Carrara  
Handle: SG17 black  
Decor: Alu trim  
Order no: F0009

**AT 540** AT 530 AT 520



## FS

Colour: HFM04  
Handle: GS140  
Decor: Alu trim  
Order no: F0008

**AT 540** AT 530 AT 520 AT 500 HT 410 HT 400



**TRENDSETTER**

Doors in the „Art“ category are not only eye catching, they are all unique. Each door has its own individual surface and in combination with metal trim or side lights they become a style focus.



**FR**

Colour: Frame RAL9005  
 Sash: SD08 Art-Basalt  
 Handle: GKV03 black  
 Decor: Alu trim  
 Order no: F0007

- AT 540
- AT 530
- AT 520
- AT 500
- HT 400
- HT 410



**FA**

Colour: Frame RAL9005  
 Sash: SD07 Art-Stone  
 Handle: KGS04  
 Order no: F0001

- AT 540
- AT 530
- AT 520
- AT 510
- AT 500
- HT 410
- HT 400

# SERIES.V

## MODERN & VISIONARY

**NEW**

Stunning new designs and exceptional quality meet even the most demanding ideals of modern living. Our new designer doors combine elegance and individuality and surprise with stylish detailing.





Cleverly positioned glass sections create an elegant look.



**VK**

Colour: Frame HM819  
Sash: HM819, RAL9005  
Handle: GPRV black  
Order no: V0005

**AT 540** **AT 530**



**VN**

Colour: Frame HM712  
Sash: HM712, RAL9005  
Glass: Satinato white  
Order no: V0002

**AT 540** **AT 530**



## VG

Colour: Frame RAL9005  
Sash: SD10 Antique wood  
Handle: GKVV black  
Order no: V0003

AT 540 AT 530

”

Every time you enter  
your house, you should  
get that special feeling of  
being at home.

Denis Vesel, Founder VESEL design

“





**VD**

Colour: RAL9005  
Handle: GSHG black  
Order no: V0001

AT 540 AT 530



**VP**

Colour: Frame RAL9005  
Sash: SD03 Art-Concrete, RAL9005  
Handle: GSIV black  
Order no: V0004

AT 540 AT 530

# SERIES.P

## BALANCED & STRUCTURED

This extensive range of doors impresses with its simplicity and symmetry. Whether you opt for a full length slim glass window or prefer perfectly aligned smaller windows in the centre or the side, the choice is yours.

To create an even more individual entrance door, you have the option to add milled grooves or decorative trims.





**WOW EFFECT**

Tactile ceramic surfaces create cutting edge entrance doors. They become a focal point within any architectural style.



**PG**

Colour: Frame HM721  
 Sash: SD06 Art-Steel  
 Handle: RGS02  
 Glass: Satinato white  
 Order no: P0004

- AT 540
- AT 530
- AT 520
- AT 510
- AT 500
- HT 410
- HT 400



**PM**

Colour: Frame RAL9005  
 Sash: SD07 Art-Stone  
 Handle: KGS05  
 Glass: Satinato white  
 Order no: PO0007

- AT 540
- AT 530
- AT 520
- AT 510
- AT 500
- HT 410
- HT 400

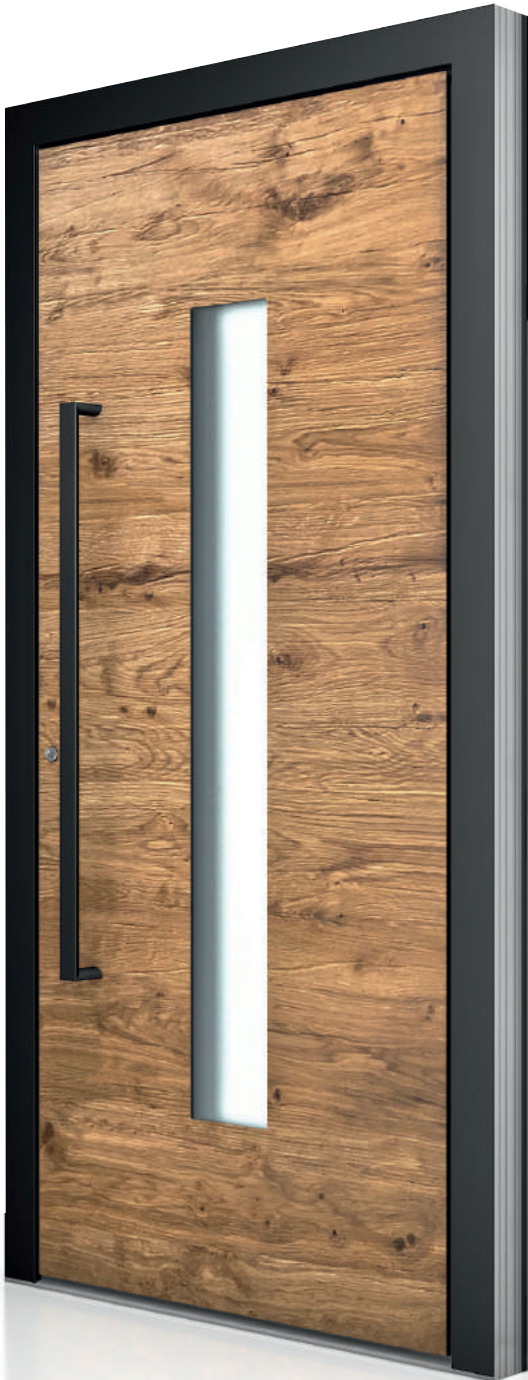

**PA**

Colour: Frame RAL9005  
 Sash: HGS01 black  
 Glass: Satinato white  
 Order no: P0001

AT 540 AT 530 AT 520 AT 510 AT 500 HT 410 HT 400



**PS**

Colour: HM817  
 Handle: GSI03 black  
 Motif glass: MP43FE  
 Order no: P0012

AT 540 AT 530 AT 520 AT 500 HT 410 HT 400





**PJ**

Colour: HF113  
Handle: KGS03  
Glass: Satinato white  
Order no: P0005

AT 540 AT 530 AT 520 **AT 500** HT 410 HT 400



**PK**

Colour: M916  
Handle: RGS03  
Glass: Satinato white  
Order no: P0006

AT 540 **AT 530** AT 520 AT 500 HT 410 HT 400



**PP**

Colour: HFM12  
Handle: RGS05  
Glass: Satinato white  
Order no: P0009

**AT 540** AT 530 AT 520 AT 510 AT 500 HT 410 HT 400





**PN**

Colour: Frame HM907  
 Sash: HM907, M916  
 Handle: GKV03  
 Glass: Satinato white  
 Alunux glass frame  
 Order no: P0008

- AT 540
- AT 530
- AT 520
- AT 500
- HT 410
- HT 400



**PQ**

Colour: Frame HM721  
 Sash: HM721, HM907  
 Handle: SG18  
 Glass: Satinato white  
 Order no: P0010

- AT 540
- AT 530
- AT 520
- AT 500
- HT 410
- HT 400







**PE**

Colour: HM716  
Handle: EGS01  
Glass: Satinato white  
Order no: P0003

- AT 540
- AT 530
- AT 520
- AT 500
- HT 410
- HT 400



**PR**

Colour: HM716  
Handle: RGS02  
Glass: Satinato white  
Order no: P0011

- AT 540
- AT 530
- AT 520
- AT 510
- AT 500
- HT 410
- HT 400

# SERIES.D

## DISCREET & ELEGANT

This beautifully designed range focuses on discreet, narrow glass windows and rectangular cut-outs, enhancing the overall appearance. Milled grooves and decorative trims add further individual touches.





**DG**

Colour: Frame RAL9005  
Sash: HM704  
Handle: SG17  
Glass: Satinato white  
Alunox glass frame  
Decorative strip: Alunox 20mm  
Order no: D0004

**AT 540** AT 530 AT 520 AT 500 HT 410 HT 400



**DD**

Colour: HM716  
 Handle: GOK60  
 Glass: Satinato white  
 Decor: Alu trim  
 Decorative strip: Alunox 20mm  
 Order no: D0003

AT 540 AT 530 AT 520 AT 500 **HT 410** HT 400



**DP**

Colour: RAL5010  
 Handle: GD25  
 Glass: Satinato white  
 Order no: D0007

AT 520 **AT 500** HT 400



Black keyhole rosette available to match black door handle.



**DH**

Colour: Frame RAL9017  
Sash: SD03 Art-Concrete  
Handle: KGS04 black  
Decor: Alu trim  
Glass: Satinato white  
Order no: D0005

- AT 540
- AT 530
- AT 520
- AT 500
- HT 410
- HT 400



**DR**

Colour: Frame RAL9005  
Sash: SD10 Antique wood  
Handle: HGS03 black  
Decor: Alu trim  
Glass: Satinato white  
Order no: D0008

- AT 540
- AT 530
- AT 520
- AT 500
- HT 410
- HT 400



**DM**

Colour: Frame HFM12  
 Sash: HFM12, M916  
 Handle: HGS04  
 Glass: Satinato white  
 Order no: D0006

AT 540 AT 530 AT 520 **AT 500** HT 410 HT 400



**DB**

Colour: Frame HM721  
 Sash: SD05 Art-Corten  
 Handle: KGS01  
 Glass: Satinato white  
 Order no: D0002

**AT 540** AT 530 AT 520 AT 510 AT 500 HT 410 HT 400



**DA**

Colour: HDS08

Handle: HS40

Glass: Satinato white

Order no: D0001

AT 540 AT 530 AT 520 AT 510 AT 500 **HT 410** HT 400

# SERIES.G

## CONCISE & CLEAR

With the third series in this range, the emphasis is very clearly on the glass elements. Depending on model and personal preference, milled grooves and decorative trims can be added.





**GJ**

Colour: Frame HF735  
Sash: HF735, HF716  
Handle: SG13  
Glass: Satinato white  
Decorative strip: Alunox 80mm  
Order no: G0004

AT 540 **AT 530** AT 520 AT 500 HT 410 HT 400



**GA**

Colour: HM716  
Handle: HS42  
Glass: Satinato white  
Order no: G0001

**AT 540** AT 530 AT 520 AT 510 AT 500 HT 410 HT 400



**GD**

Colour: HFM05  
Handle: KGS04  
Glass: Satinato white  
Decorative strip: Alunox 80mm  
Order no: G0002

**AT 540** AT 530 AT 520 AT 510 AT 500 HT 410 HT 400











*Design your own entrance door with our clever Door Designer tool. Upload a picture of the front of your house and create your bespoke door.*



**TRANSOM DESIGN**

Colour: HM716  
Handle: HS50  
Glass: Satinato white  
Bars: 97mm  
Order no: X0002

AT 500



**GEORGIAN BAR DESIGN**

Colour: HM722  
Handle: HS30  
Glass: Satinato white  
Bars: 60mm/40mm  
Order no: X0006

AT 500

# ENTRANCE DOORS

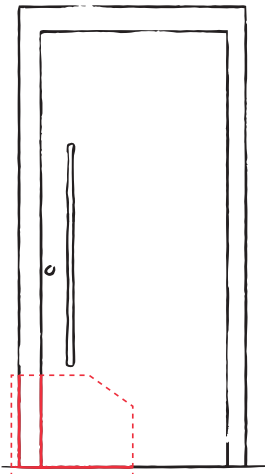

**AT 540**

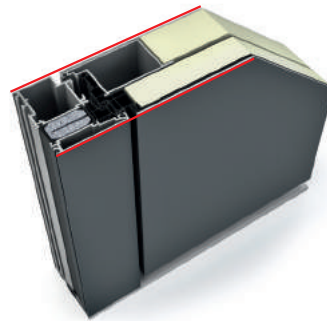



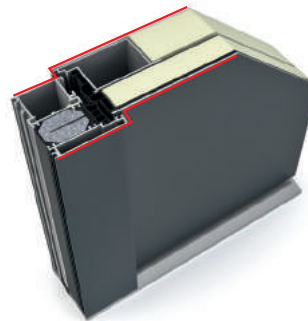

**AT 530**

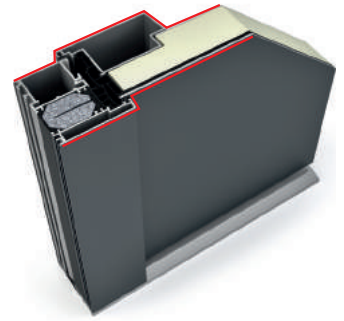

**AT 520**



<b>Material</b>	Aluminium	Aluminium	Aluminium
<b>Design</b>	Flush inside and outside	Square edge on inside and outside	Round edge on inside, square edge on outside
<b>Thermal insulation</b> in $W/(m^2K)$	 $U_D$ up to 0.78	$U_D$ up to 0.75	$U_D$ up to 0.81
<b>Noise reduction</b> in dB	 up to 35	up to 34	up to 32
<b>Security</b>	 up to RC2	up to RC2	up to RC2
<b>Locking</b>	 Multi-point locking	Multi-point locking	Multi-point locking
<b>Construction Depth</b> in mm	 93	93	93
<b>Gasket</b>	3	3	3
<b>Threshold</b>	Thermally broken	Thermally broken	Thermally broken
<b>Insulation</b>	3-chamber frame profile, insulating foam core	3-chamber frame profile, insulating foam core	3-chamber frame profile, insulating foam core



### AT 510

### AT 500

### HT 410

### HT 400

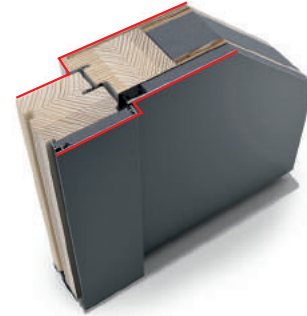

Aluminium	Aluminium	Timber-Aluminium	Timber-Aluminium
Round edge on inside, square edge on outside	Round edge on inside and outside	Flush inside and outside	Square edge on inside and outside
U <sub>b</sub> up to 0.98	U <sub>b</sub> up to 0.91	U <sub>b</sub> up to 0.58	U <sub>b</sub> up to 0.73
up to 38	up to 40	up to 34	up to 34
up to RC2	up to RC3	up to RC2	up to RC2
Multi-point locking	Multi-point locking	Multi-point locking	Multi-point locking
93	93	121	85
3	3	3	3
Thermally broken	Thermally broken	Thermally broken	Thermally broken
3-chamber frame profile, insulating foam core	3-chamber frame profile, insulating foam core	Thermal foam insulation	Thermal foam insulation

# DOOR HANDLES

## RECESSED HANDLES

Both attached and flush possible. Only attached version possible with the AT500 and AT520.



### SG16

Recessed handle, 430x100  
Stainless steel  
AT500, AT520, AT530, AT540, HT400, HT410



### SG13

Recessed handle, 220x125  
Stainless steel  
AT500, AT520, AT530, AT540,  
HT400, HT410



### SG17

Recessed handle,  
110x500  
Stainless steel, black  
AT500, AT520, AT530,  
AT540, HT400, HT410

LED lighting optional  
with AT530 and AT540



### SG18

Recessed handle,  
110x1400  
Stainless steel  
AT500, AT520, AT530,  
AT540, HT400, HT410

LED lighting optional-  
with AT530 and AT540

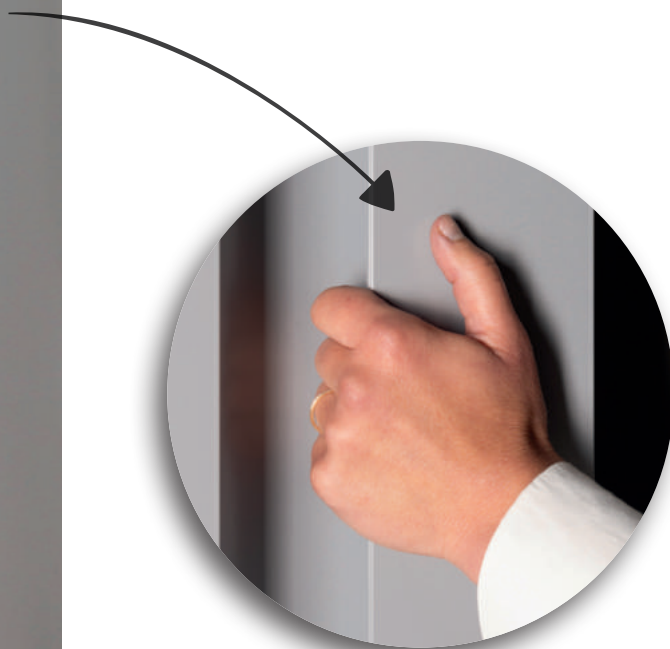

### GSIV

Integrated recessed handle

### GS140

406x59

### GS101

1000x59

### GS102

1200x59

### GS103

1400x59

### GSIV

Length variable

in the corresponding colour of  
the door sash, black  
AT500, AT520, AT530,  
AT540, HT400, HT410

LED lighting optional



# BAR HANDLES



**HGS01**  
Handle bar half-round  
40x1000  
2 supports

**HGS02**  
40x1200  
2 supports

**HGS03**  
40x1400  
2 supports

**HGS04**  
40x1600  
2 supports

Stainless steel, black  
AT500, AT520, AT530, AT540, HT400, HT410



**KGS01A**  
for ekey-dLine  
Square handle bar  
40x1000  
2 supports

**KGS05A**  
for ekey-dLine  
Square handle bar  
40x1800  
3 supports

Stainless steel  
AT530, AT540, HT400, HT410



**KGS01**  
Square handle bar  
40x1000  
2 supports

**KGS02**  
40x1200  
2 supports

**KGS03**  
40x1400  
2 supports

**KGS04**  
40x1600  
3 supports

**KGS05**  
40x1800  
3 supports

**KGS06**  
40x2000  
3 supports

Stainless steel, black  
AT500, AT510, AT520, AT530, AT540, HT400, HT410

**KGS01L**  
(without ill.)  
40x1000  
2 supports with integrated LED lighting

**KGS03L**  
(without ill.)  
40x1400  
2 supports with integrated LED lighting

Stainless steel  
AT530, AT540, HT400, HT410



**RGS01**  
Round handle bar  
Ø 30  
Height 1000  
2 Supports

**RGS02**  
Height 1200  
2 Supports

**RGS03**  
Height 1400  
2 Supports

**RGS04**  
Height 1600  
3 Supports

**RGS05**  
Height 1800  
3 Supports

**RGS06**  
Height 2000  
3 Supports

Stainless steel  
AT500, AT510, AT520, AT530, AT540, HT400, HT410



**EGS01**  
Round handle bar  
Ø 35  
Height variable

Stainless steel  
AT500, AT510, AT520, AT530, AT540, HT400, HT410



**GKV01**  
Square handle bars with straight ends  
30x1000

**GKV02**  
30x1200

**GKV03**  
30x1400

**GKV04**  
30x1600

Stainless steel, black  
AT500, AT520, AT530, AT540, HT400, HT410



**RSS01**  
Round Handle bars with angled supports  
Ø 32  
Height 1000  
2 Supports

**RSS02**  
Height 1200  
2 Supports

**RSS03**  
Height 1400  
2 Supports

**RSS04**  
Height 1600  
3 Supports

**RSS05**  
Height 1800  
3 Supports

**RSS06**  
Height 2000  
3 Supports

Stainless steel  
AT500



**GOK60**  
Handle bar  
Height 600  
2 Supports  
Stainless steel  
AT500, AT520, AT530, AT540, HT400, HT410



**GKV60**  
Handle bar  
Height 600  
2 Supports  
Stainless steel, black  
AT500, AT520, AT530, AT540, HT400, HT410



**GPR60**  
Handle bar  
Height 600  
2 Supports  
Stainless steel  
AT500, AT520, AT530\*, AT540\*, HT400\*, HT410\*

**GPR60A**  
for ekey dLine  
Height 600  
2 Supports

**GPR60L**  
with integrated LED lighting  
Height 600  
2 Supports

**A stylish selection of handles is available for all door series.**

Please note that not all handles are available on all doors.

The pictured handles are not in proportion and this page only shows a selection of handles available.

Dimensions are in mm, width x height.

# PUSH AND BRACKET HANDLES



**HS10**  
Push handle  
93x400  
Stainless steel  
AT500, AT510, AT520,  
AT530, AT540,  
HT400, HT410



**HS50**  
Push handle  
109x500  
Stainless steel  
AT500, AT510, AT520,  
AT530, AT540,  
HT400, HT410



**HS40**  
Push handle  
90x500  
Stainless steel matt  
AT500, AT510, AT520,  
AT530, AT540,  
HT400, HT410



**HS42**  
Push handle  
90x500  
Stainless steel  
AT500, AT510, AT520,  
AT530, AT540,  
HT400, HT410



**PB30**  
Tubular U-handle  
100x300  
Stainless steel  
(PB31 = AluF1)  
AT500



**HS32**  
Push handle  
118x477  
Stainless steel  
(HS30 = ring  
Stainless steel matt)  
AT500, AT510, AT520,  
AT530, AT540,  
HT400, HT410



**GKN201**  
Stainless steel  
AT500

# LEVER



**GD25**  
Stainless steel, black  
AT500, AT510, AT520,  
AT530, AT540, HT400, HT410



**PD12**  
Aluminium brushed  
AT510, AT520,  
AT530, AT540



**GD10**  
Stainless steel  
AT500, AT510, AT520, AT530,  
AT540, HT400, HT410



**GD15**  
Stainless steel, black  
AT500, AT510, AT520, AT530,  
AT540, HT400, HT410



**GD20**  
Stainless steel  
AT500, AT510, AT520, AT530,  
AT540, HT400, HT410



**GD30**  
Stainless steel  
AT500, AT510, AT520,  
AT530, AT540, HT400,  
HT410



**SD10**  
Stainless steel, black  
AT510, AT520, AT530, AT540,  
HT400, HT410



**SD15**  
Stainless steel  
(SD20 = Alu Natural, SD25 = Alu white)  
AT500, AT510, AT520, AT530





# COLOURS

## EXTERNAL AND INTERNAL COLOURS

Please note that not every colour is available for every door, frame or door sash.

Due to printing and manufacturing technology, colour and surface deviations between illustration and original products may occur.

Your **Internorm partner** will be happy to show you original colour samples.

### STANDARD COLOURS\*



\* **Highly weather resistant**, except M916 (facade quality).

\*\* Intensive colour appearance, variation possible.

\*\*\* For surface options **HM** (highly weather-resistant standard colour), **HF** (highly weather-resistant fine structure), **HFM** (highly weather-resistant fine structure metallic), a special highly weather-resistant powder coating is used.

### HDS COLOURS\*\*



### hirest-COLOURS\*\*\*

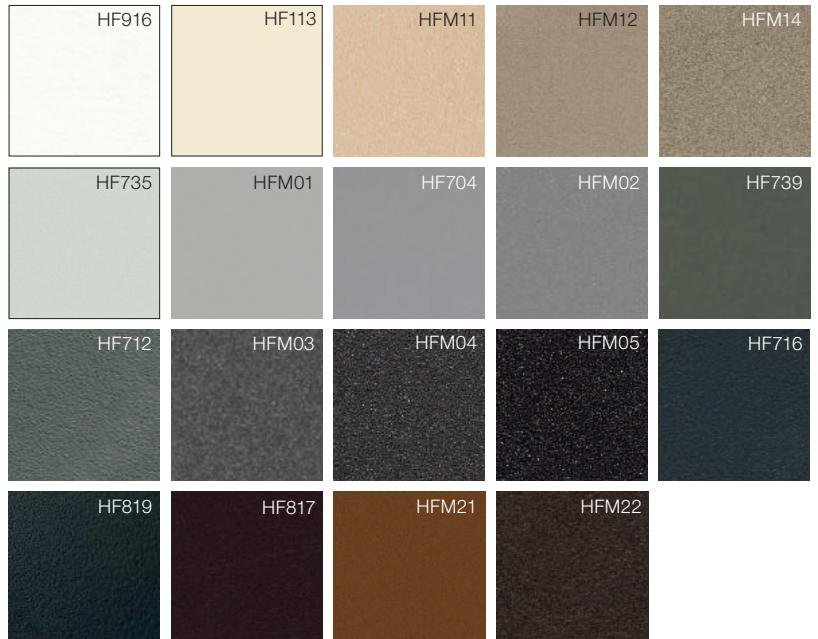



STAINLESS STEEL COLOURS



*Please note*

The Internorm RAL colour range (facade quality) offers even more design options.



EXTERNAL COLOURS

SD COLOURS

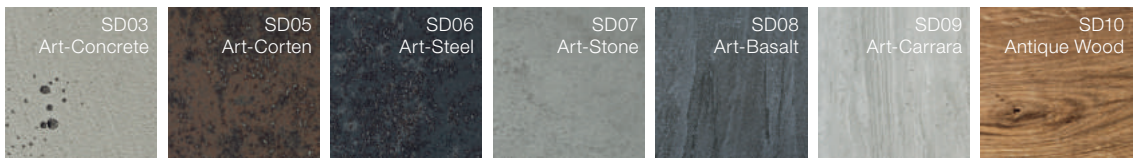

INTERNAL COLOURS

TIMBER STANDARD COLOURS

SPRUCE

varnished



SPRUCE

opaque

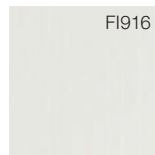

ASH



WALNUT



OAK



LARCH varnished



# YOUR FINGER IS THE KEY

No more tedious searching for keys, thanks to fingerprint scanners or keypads. At Internorm, these intelligent systems are attached to or integrated flush into the door sash or handle.

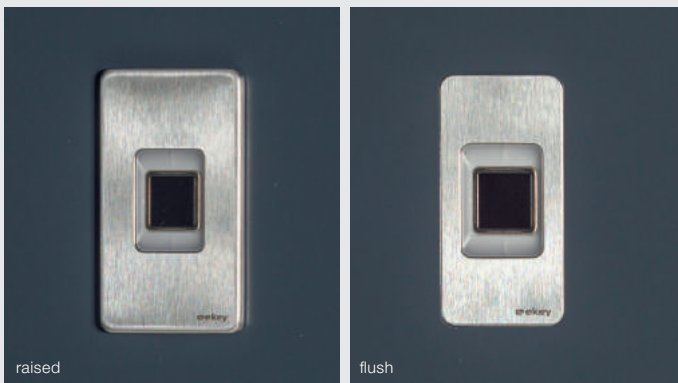

## FINGERPRINT SCANNER

The integrated, new generation 'ekey-dLine' fingerprint scanner conveniently replaces conventional keys. The control unit is space-saving and securely housed in the door sash or handle. Keys, cards, or codes are no longer forgotten, lost or stolen.

**Simple.** You open the door with just your finger via the ekey-bionyx App. There is no need for a technician – you are in control. The intelligent software learns with every use and recognises children's growing fingers or changes in user habits.

**Secure.** Your unique fingerprint is more secure than a key, which can be lost or stolen. Manipulation of the system from the outside and unauthorised use is made impossible.

**'Smart' entrance door.** The system can be integrated into your Smart Home system via Wifi and therefore offers countless features, including remote opening or push notifications when door is being opened. Even a quick 'Alexa, open the door' will activate it if you are tied up. The programming and management of the fingerprint scanner is via smartphone or tablet. The Bluetooth connection is secured by a 6-digit coupling code. Suitable for Apple and Android mobile phones or tablets.

## KEYPAD

A more traditional option for securely entering your home is a keypad. The slim and smart ekey home integra keypad is installed directly into the door sash or in the wall next to the door. The system is compatible with all E-openers and motorised locks. A cable transports the encrypted opening signal to an electronic relay. The relay sends the opening impulse to the motor lock. The system cannot be manipulated from the outside.

The lock is opened by your individual four to ten-digit code. The touch-sensitive pad can even remember a pattern just like on a mobile phone.

Up to 99 codes can be programmed and each user will have their own access code. You can manage and limit the access of individuals to certain times or days, for example cleaners.

Additional security features, such as the Winkhaus high security cylinder, door restrictor, electric door opening/ETOE and chrome spy hole are available on request from your Internorm partner.







# SIDE ENTRANCE DOORS

Side entrance doors serve to close off unused, unheated rooms (e.g. garage, basement storage rooms). Current statistics show that intruders predominantly gain access to a house via side and back entrances. It is therefore all the more important to consider relevant security features – Internorm offers different security systems upon request.

Side entrance doors are available in timber-aluminium, aluminium and uPVC and offer a wide range of individual design options.

## TIMBER-ALUMINIUM



**HF 410**



**HF 410**

## ALUMINIUM



**AT 500** panel model  
Colour: HM704, handle: HS10  
Order no.: X0008



**AT 500** Glass model  
Colour: Frame M916, handle: HS10  
Glass: Satinato white  
Order no.: X0009







uPVC



**AT 500** Glass panel model

Colour: HM716, handle: HS10  
Glass: Satinato white  
Order no.: X0010



**KF 410**



**AT 500** Glass panel model

Colour: HM735, handle: HS10  
Glass: Satinato white  
Order no.: X0011



**KF 310**



**KF 310**

# WARRANTIES

OUR WARRANTIES ENSURE THAT YOU CAN ENJOY YOUR INTERNORM PRODUCTS FOR MANY YEARS TO COME.

As the leading European, internationally active, window brand with 91 years of experience, Internorm is focused on developing innovative, exceptionally high quality and reliable window and door solutions. That's our guarantee.

Warranty

**15**  
YEARS

- Against condensation between the sealed panes of insulating glass, if the glass is not heavier than 80kg.

Warranty

**10**  
YEARS

- On weather resistance against unnatural change of colour and cracks in surfaces of:
  - white uPVC window and door profiles, except for mitre cracks.
  - inside foil covered uPVC window and door profiles, except for mitre cracks.
  - anodised (a form of metal coating) or powder coated aluminium window and door profiles.
- Against condensation between the sealed panes of insulating glass.
- On the glue connection of glued Georgian/feature bars.
- On the function of the material compound timber, thermal foam and aluminium profiles in timber aluminium composite products when adhering to the Internorm fitting and maintenance guidelines.
- On the function of the glued connection and sealing of the insulating glass panes with window profiles in timber aluminium composite products when adhering to the Internorm fitting and maintenance guidelines.
- Where goods are supplied with marine grade aluminium finish.

Warranty

**5**  
YEARS

- For PVD coated entrance door handles against corrosion, if no mechanical damage is apparent.
- On weather resistance against unnatural colour changes or cracks in door filling surfaces.

Warranty

**3**  
YEARS

- On weather resistance against unnatural change of colour and cracks in surfaces of anodised or powder coated aluminium roller shutters, blinds and window shutter profiles.
- On the function of window and door hardware when the Internorm fitting and maintenance guidelines have been followed.
- On weather resistance against unnatural change of colour and cracks in surfaces of uPVC roller shutter profiles.

Product  
Availability  
Warranty

**30**  
YEARS

Internorm guarantees that our Goods manufactured from 1999 onwards are capable of being repaired by our specialists in such a way that their full functionality is guaranteed to subsist or be retained over a time period of 30 years. However, this is subject to the construction (i.e. frames and sashes) remaining undamaged and subject to the customer paying our costs of repair, where applicable. The 30-year period begins with the Internorm production date, confirmation of which will be provided on request. The services or materials, labour time etc., necessary to retain functionality will be charged at respective current rates.

## WARRANTIES/EXTRACT:

The full version of our warranty information, warranty requirements and how to make a warranty claim, can be found in the Internorm Maintenance, Care and Warranties Manual. This Manual is delivered together with your Internorm products. It is additionally available as a PDF from the Download section of our website, and available from every **Internorm distribution partner**.



# NATIONAL AND INTERNATIONAL CERTIFICATIONS CONFIRM THE HIGH QUALITY OF OUR PRODUCTS.

Internorm's wealth of experience and focus on innovative technical solutions ensure that you receive the best product and service. High-tech production facilities and the strictest quality controls ensure that the our product quality sets industry standards. Prestigious awards and certifications from leading European test institutes confirm this.



Austrian State Emblem



Austrian Quality Label



TÜV



Institute for Window Technology  
Rosenheim



RAL Quality Seals



Technical University Graz



QUALITÄTS  
FENSTER  
MADE IN AUSTRIA



Minergie® Certificate



Austrian Society for  
Environment Simulation



Certificate for products from  
sustainable forestry

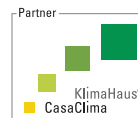

KlimaHaus Certificate



Climate Association  
Town Traun



Energy Globe  
(Project Schiestlhaus)



VinylPlus Certificate



EnergieGenie 2016  
(HF 410)



EnergieGenie 2020  
(KF 520)



## IMPRINT

**Publisher:** Internorm International GmbH, Ganglgutstraße 131, A-4050 Traun

**Photos:** Studio Hoflehner, A-4600 Wels | studio46, A-4863 Seewalchen am Attersee | Isa Stein, Studio für Kunst und Architektur, A-4020 Linz | Bernhard Hörtnagl, A-6020 Innsbruck | Internorm International GmbH, A-4050 Traun

**Design and Litho:** Internorm International GmbH, A-4050 Traun

**Print:** Hague Group, Leicester, LE19 4SD, UK

Subject to technical changes, layout and printing errors.

Internorm International GmbH is an ARA licence partner: Our licence number is 4477.

HOME IS NOT A  
PLACE, IT'S  
*a feeling.*







Andreas Simmer  
UK Managing Director



- Internorm manufacturing sites (production exclusively in Austria)
- Internorm offices
- Internorm distribution partners

# AN ESTABLISHED INTERNATIONAL FAMILY BUSINESS

## EUROPE'S NO. 1 WINDOW BRAND

**Thank you for your interest in Internorm products. Internorm has been a family business for 91 years, having developed from a one-man blacksmith's shop to the largest internationally active window brand.**

During this time we have manufactured over 27 million window and door units, all 100% made in our production facilities in Traun, Sarleinsbach and Lannach in Austria. From the creation of the uPVC window and the production of the timber-aluminium window to today's high-tech and ultra-modern design innovations, our family company has been setting standards across Europe. We are pioneers in our field and continue to further develop technology and innovative ideas.

Our 1974-strong European work force are specialists, who thrive on attention to detail and act with passion and integrity. Together with more than 1300 distribution partners in 21 countries we guarantee product quality and the highest levels of service.

# Internorm®

## Internorm Windows UK Ltd

Unit D · Colindale Business Park  
2-10 Carlisle Road · London, NW9 0HN  
Tel.: +44 (0) 208 205 9991  
Email: [office@internorm.co.uk](mailto:office@internorm.co.uk)

[uk.internorm.com](http://uk.internorm.com)  
[commercial.internorm.com](http://commercial.internorm.com)

