



DOORS

Highlights of Architecture

CONTENT

DOOR MODELS

Door leaf with glass cut-out	8
Solid door leaf	28
Door leaf with glass cut-out	32

SECURITY

Safety features	34
-----------------	----

PRESENTATION

Design	36
Overview technology	40
Handles	42
Colours	48

COMPANY

We are offering you	52
Customer Care	53
Warranties	54
Certifications	55

www.internorm.com





SOLID YET SUSPENDED

The white, clearly structured building seems to float above the white base. The timber-aluminium entrance door highlights this architectural solution.

Detached house (A), door: HT 410, window HF 310





ALUNOX GLASS SURROUND

Draw attention to the simplicity and elegance of your entrance door in a discreet manner with an Alunox glass surround. The matt brushed glass surround forms the ideal frame for your glass cut-out..



GG

Colour: HF113
Handle: MGSE10
Glass: Satinato white,
Alunox glass surround
Order no: 19-014

AT 410 AT 400 AT 310 HT 400 HT 410



GA

Colour: frame HM716,
Handle: HS42
Glass: Satinato white
Order no: 19-015

AT 410 AT 400 AT 310 AT 305 HT 400 HT 410

TIMBER APPEARANCE

You want to see the timber
appearance on the outside?
Why don't you use
HDS or HDH colours
with vibrant timber grain?



DA

Colour: HDS08
Handle: HS40
Glass: Satinato white
Order no: 19-016

AT 410 AT 400 AT 310 AT 305 HT 400 **HT 410**

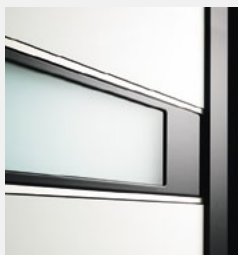

ELEGANCE

The combination of high gloss and matt surfaces is especially attractive. The modern design is rounded off through stainless steel heavy duty joiners and a sophisticated glass insert.



DL

Colour: frame HM716, sash M916,
SD04 high gloss black
Handle: SG16
Glass: Satinato white
Designer elements: heavy duty joiners
Order no: 19-017

AT 410 AT 400 AT 310 HT 400 HT 410



DJ

Colour: M916
Handle: RGS02
Glass: Satinato white
Order no: 19-018

AT 310

DOOR LEAF WITH GLASS CUT-OUT

FRAMELESS SIDE ELEMENT

This entrance door looks stylish with frameless side elements. These are rendered into the brickwork and almost disappear completely. The insulating glass finishes flush with the door frame and looks elegant.



DB

Colour: HM721

Handle: FS20

Glass: Satinato white

Order no: 19-019

AT 410 AT 400 AT 310 AT 305



DD

Colour: HM716
 Handle: TEG15
 Glass: Satinato white
 Designer elements: heavy duty
 joiners
 Order no: 19-020

AT 410 AT 400 AT 310 HT 400 HT 410



PN

Colour: frame HM907,
 sash HM907, M916
 Handle: EGS06
 Glass: Satinato white
 Alunox glass surround
 Order no: 19-021

AT 410 AT 400 AT 310 HT 400 HT 410

NEW:

Real wood with old wood look



PA

Colour: Frame HM721 - SD10

Handle: HGS01

Glass: Satinato White

Order no: 20-026

AT 410 AT 400 AT 310 AT 305 HT 400 HT 410



PQ

Colour: frame HM721,

sash HM721, HM907

Handle: SG18

Glass: Satinato white

Order no: 19-023

AT 410 AT 400 AT 310 HT 400 HT 410





PR

Colour: HM716
Handle: KGS03
Glass: Satinato white
Order no: 19-024

AT 410 AT 400 AT 310 HT 400 HT 410



GJ

Colour: M916
Handle: MGSE10
Glass: Satinato white
Order no: 19-025

AT 410 AT 400 AT 310 HT 400 HT 410



DM

Colour: frame HFM12,
sash HFM12, M916
Handle: MGSE6
Glass: Satinato white
Order no: 19-026

AT 410 AT 400 AT 310 HT 400 HT 410



GY

Colour: HM704
Handle: HS50
Glass: Satinato white
Order no: 19-027

AT 305

DOOR LEAF WITH
GLASS CUT-OUT



PD

Colour: HM906

Handle: MGSE10

Glass: Satinato white

Order no: 19-028

AT 410 AT 400 AT 310 HT 400 HT 410

Internormi



TRADITIONAL

Sustainable, ecological with a classic building style combined with modern window and door elements.

Entrance door AT 410 Art-Concrete, window KF 410



BASE

Internorm entrance doors are available with or without Alunox base - for protection or as a designer element.



DP

Colour: RAL5010
Handle: MGSE6
Glass: Satinato white,
Alunox glass surround
Order no: 19-029

AT 310 HT 400



PP

Colour: HFM12
Handle: RGS05
Glass: Satinato white
Order no: 19-030

AT 410 AT 400 AT 310 AT 305 HT 400 HT 410

DOOR LEAF WITH GLASS CUT-OUT

COMPACT DESIGN

The glass of the side element meets directly with the door frame which connects with the door in one unit. Upon request, frame and door leaf can be designed in different colours.



PJ

Colour: HF113
Handle: MGSE10
Glass: Satinato white
Order no: 19-031

AT 410 AT 400 AT 310 HT 400 HT 410







PG

Colour: HFM11
Handle: RGS02
Glass: Satinato white
Order no: 19-032

AT 410 AT 400 **AT 310** AT 305 HT 400 HT 410



PM

Colour: HF113
Handle: FS10
Glass: Satinato white
Order no: 19-033

AT 410 AT 400 **AT 310** AT 305 HT 400 HT 410



PK

Colour: M916
Handle: RGS03
Glass: Satinato white
Order no: 19-034

AT 410 AT 400 AT 310 HT 400 HT 410



DI

Colour: frame HM907, sash M916
Handle: SG13
Glass: Satinato white
Designer elements: heavy duty joiners
Order no: 19-035

AT 410 AT 400 AT 310 HT 400 HT 410



GJ

Colour: frame HF735,
sash HF735, HF716
Handle: MGSE10
Glass: Satinato white
Order no: 19-011

AT 410 AT 400 AT 310 HT 400 HT 410



GD

Colour: HFM05
Handle: KGS04
Glass: Satinato white
Order no: 19-012

AT 410 AT 400 AT 310 AT 305 HT 400 HT 410

DOOR LEAF WITH
GLASS CUT-OUT



DG

Colour: M916
Handle: SG17
Glass: Satinato white,
Alunox glass surround
Order no: 19-013

AT 410 AT 400 AT 310 HT 400 HT 410

CONCRETE APPEARANCE

Each Art-Concrete entrance door demonstrates its own individual surface – each door is therefore unique.



FK

Colour: frame RAL9017, sash SD03 Art-Concrete

Glass: Satinato white

Handle: SG13

Designer elements: heavy duty joiners

Order no: 19-007

AT 410 AT 400 AT 310 HT 400 HT 410



FM

Colour: frame HM704,
sash HM704, M916
Handle: KGS03
Order no: 19-008

AT 410 AT 400 AT 310 HT 400 HT 410



FD

Colour: frame HM716,
sash HM716, HM907
Handle: RGS05
Order no: 19-009

AT 410 AT 400 AT 310 HT 400 HT 410

TRENDSETTER

Our doors in Art-Stone, Art-Steel und Art-Corten are unique specimens. Each ceramic plate has its own individual surface. Additionally, the ceramic surface is scratch-resistant and always immaculate. Combined with heavy duty joiners or side elements they become the style element of each house.



FA

Colour: frame HM716,
sash SD06 Art-Steel
Handle: KGS03
Order no: upon technical request

AT 410 AT 400 AT 310



FA

Colour: frame HM716,
sash SD07 Art-Stone
Handle: KGS04
Order no: upon technical request

AT 410 AT 400 AT 310

EXPERIENCE THE DOOR INTERACTIVELY

Have a look at how the door could fit into your entrance area, look at it from all sides and change the surface. All this is possible now with the Internorm AR App.



Download your
Internorm AR App
for free in Google
Play Store and
iApple App Store



FJ

Colour: frame HM716,

sash SD05 Art-Corten

Handle: KGS04

Glass: Satinato white

Designer elements: heavy duty
joiners

Order no: upon technical request

AT 410 AT 400 AT 310





K RA-S1B

Colour: HM704
Handle: HS10
Glass: Satinato white
Order no: 19-060

AT 200



K RA-G1B

Colour: M916
Handle: HS10
Glass: MRI
Order no: 19-061

AT 200

GLASS FRAME

We are offering you doors with profiled glass frames for your home. These can be designed independently from the door leaf colours.



AM

Colour: M916
Handle: HS10
Glass: D03
Order no: 19-040

AT 310



AJ

Colour: HM817
Handle: VD14
Glass: D41
Order no: 19-041

AT 310



AA

Colour: HDS08
Handle: BS11
Glass: Satinato white
Order no: 19-042

AT 400 AT 310 HT 400



AG

Colour: frame HF113,
sash HF113, M916
Handle: HS40
Glass: Satinato white
Order no: 19-043

AT 400 AT 310 HT 400

YOUR FINGER IS THE KEY

No need to look for that key again due to the finger scanner or keypad.
With Internorm, these technologically clever systems are fastened to the door leaf or integrated flush in the door leaf or handle.

NEW
Door handle
with integrated
finger scanner!



FINGER SCANNER

The integrated finger scanner replaces the conventional key in a convenient way without exception. The control unit is space-saving and securely situated in the door sash. Keys, cards or codes can no longer be forgotten, lost or stolen.

Simple. You can open the door by simply “sliding your fingers across”. You can save your own authorised individual meaning, no need for technicians.

Convenient. You always have your key “at hand”.

This clever software is so intelligent that it learns with every scan and even recognises growth in children’s fingers or changes in user behaviour.

Secure. Your unique finger print is more secure than a key which can be lost or stolen. Control of the system from the outside is impossible. Removal of this is also impossible.

Scanner generally with bluetooth (BT) interface and optionally also with transponder. Programming and admin of finger scanner via Smartphone or tablet. The bluetooth connection is secured through a 6 digit coupling code. Suitable for Apple and Android phones or tablets.



KEYPAD

The ekey home integrated keypad is fitted directly into the door sash or the wall next to the door. Only the ultra-flat decor element is visible.

The system is compatible with all e-openers and electric locks. A cable transports an encoded opening signal to an electronic relais. The relais sends an opening impulse to the electric lock. Control from the outside is therefore impossible.

Opening occurs by typing in a four to ten digit code of your choice. A six digit code is very secure and easy to remember. A pattern can even be taught via the touch screen and by mobile phones.

Up to 99 codes can be programmed. Each user can therefore have his own access code. For example, this option allows the code to be deleted and replaced with a new code as required.



SECURE WITH WINKHAUS CYLINDERS

There is a multitude of additional components available such as high security cylinders, door blocks, signal lights etc. For more information please contact your Internorm [1st] window partner.



Symbolic photos

The **standard cylinder** is equipped with anti-scanning and drilling protection and two steel pins. It can be locked from both sides, this means, even if the key is in the lock on one door side, it can be locked or unlocked from the other side.

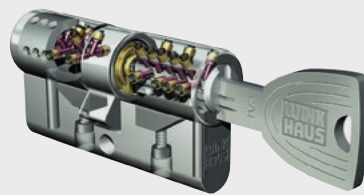

The **high security cylinder** with 3D patented antiscanning and drilling protection as well as being unable to remove or loosen. This specific key shape means smoothness of locking and prevents bending and breaking of the key. Lockable from both sides. The symmetrical reversible key can be easily inserted into the cylinder.



Each high security cylinder comes with a personal **security card**. It serves as important proof of legitimacy when reordering cylinders or keys.

ADDED SECURITY



Door block TSH serves as opening limiter. It is operated outside via the main lock (no cylinder outside). Operation on the inside via a turn knob.



Door can only be opened while contact is given (button pressed) with the **electric door opener/ETOE**.

AT A GLANCE



Door spyhole is available in chrome or brass.



ELEGANT DESIGN

The frameless side element is a unique feature. Through three-sided rending into the brickwork, the frame almost disappears altogether. The insulating glass finishes flush with the door frame to reveal a modern appearance of the entrance area.

ONE DOOR – MANY POSSIBILITIES

From simple to luxurious – the design of the entrance door is completely up to you. The rather discreet groove millings blend in perfectly with the design of the entrance door. Heavy duty joiners made from Alunox (flush) or stainless steel (raised) create a focal point.

Side elements made of glass ensure plenty of light for your home.



FG

Colour: HM716
Handle: MGSE10
Designer elements: heavy duty joiners
Order no: 19-084

AT 410 **AT 400** **AT 310**
HT 400 **HT 410**



FG

Colour: HM716
Handle: MGSE10
Designer elements: groove milling
Order no: 19-085

AT 410 **AT 400** **AT 310**
HT 400 **HT 410**

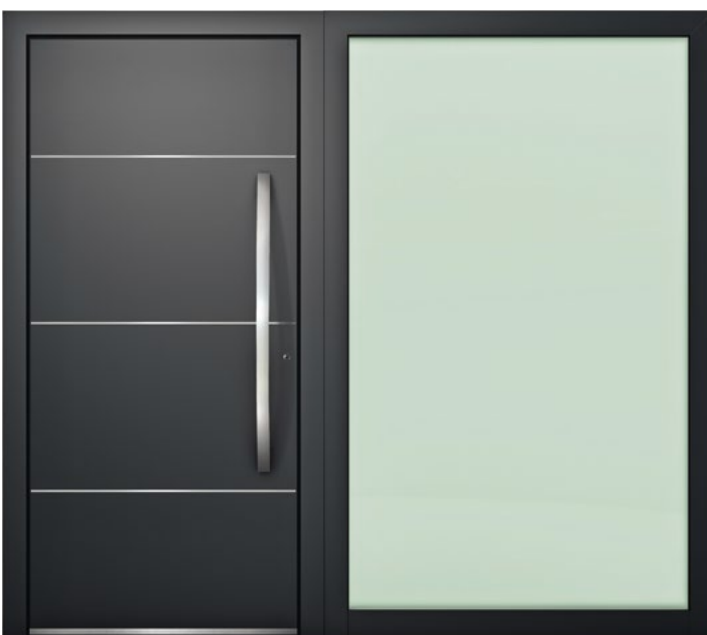

FG

Colour: HM716
Handle: MGSE10
Glass: Satinato green
Designer elements: heavy duty joiners
Order no: 19-086

AT 410 **AT 400** **AT 310** **HT 400** **HT 410**

HEAVY DUTY JOINERS AND GROOVE MILLINGS

Whether you want simple or elegant – both versions communicate charm in their own way. The rather discreet groove millings blend in perfectly with the design of the entrance door. Heavy duty joiners made from Alunox (flush) or stainless steel (raised) create a feature.



FG
Colour: HFM13
Handle: EGS01
Order no: 19-087

- AT 410
- AT 400
- AT 310
- HT 400
- HT 410

FG
Colour: HFM13
Handle: EGS01
Order no: 19-088

- AT 410
- AT 400
- AT 310
- HT 400
- HT 410

HEAVY DUTY JOINERS

These are available either flush in Alunox or raised in stainless steel.



Double groove milling



Double heavy duty joiner

FJ

Colour: HFM22
Handle: MGSE10
Order no: 19-089

- AT 410
- AT 400
- AT 310
- HT 400
- HT 410

FJ

Colour: HFM22
Handle: MGSE10
Order no: 19-090









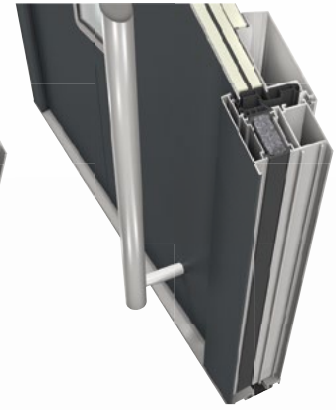
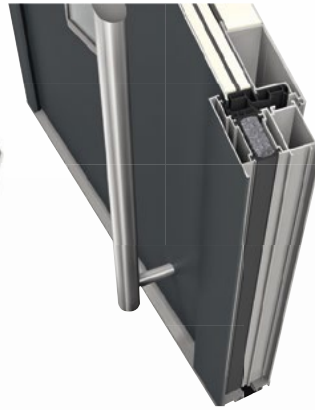
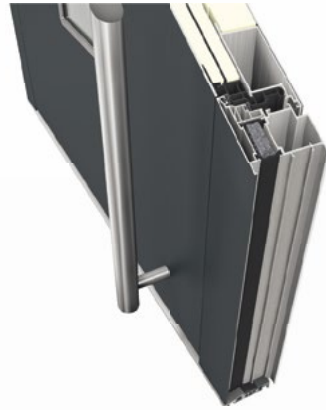

- AT 410
- AT 400
- AT 310
- HT 400
- HT 410

AT 410

AT 400

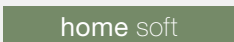
AT 310



Material	Aluminium	Aluminium	Aluminium
Thermal insulation in $W/(m^2K)$	 U_D as low as 0.78	U_D as low as 0.75	U_D as low as 0.81
Sound proofing in dB	 up to 36	up to 36	up to 33
Security	 up to RC2	up to RC2	up to RC2
Locking	 Multi-point locking	Multi-point locking	Multi-point locking
Profile construction depth in mm	 93	93	93
Gasket levels	3	3	3
Low threshold	Thermally broken	Thermally broken	Thermally broken
Insulation	3-chamber frame profile foam insulation core	3-chamber frame profile foam insulation core	3-chamber frame profile foam insulation core
Design style	 studio	 home pure  home soft  ambiente	 home pure  home soft  ambiente

AT 305

AT 200

HT 410

HT 400

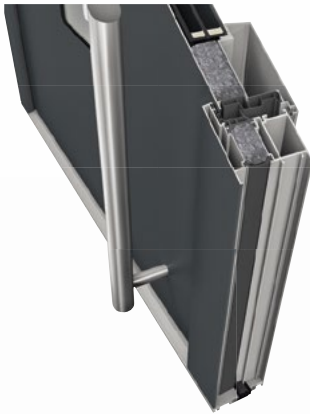

Aluminium

Aluminium

Timber-aluminium

Timber-aluminium

U_D as low as 0.98

U_D as low as 1.2

U_D as low as 0.58

U_D as low as 0.73

up to 39

up to 39

up to 34

up to 34

up to RC2

up to RC2

up to RC2

up to RC2

Multi-point locking

Multi-point locking

Multi-point locking

Multi-point locking

93

80

121

85

3

3

3

3

Thermally broken

Thermally broken

Thermally broken

Thermally broken

3-chamber frame profile insulating glass core

3-chamber frame profile foam insulation core

Thermal foam insulation

Thermal foam insulation

home pure

home soft

ambiente

home pure

home soft

ambiente

studio

home pure

home soft

ambiente

RECESSED HANDLES

Available attached and flush.

Only available attached with AT310.



SG16
Recessed handle, 430x100
stainless steel
AT310, AT400, AT410, HT400, HT410



SG13
Recessed handle, 220x125
stainless steel
AT310, AT400, AT410,
HT400, HT410



SG17
Recessed handle,
110x500
stainless steel
AT310, AT400, AT410
HT400, HT410
LED lighting available



SG18
Recessed handle,
110x1400
stainless steel
AT310, AT400, AT410
HT400, HT410
LED lighting available

HANDLE PLATE



FS10
Handle plate, 100x100
stainless steel
AT200, AT305, AT310, AT400,
AT410, HT400, HT410

BAR HANDLES



KGS01A
for ekey-Arte
square handle bar
40x1600
2 supports

KGS05A
for ekey-Arte
square handle bar
40x1800
3 supports

Stainless steel
AT400, AT410,
HT400, HT410



KGS01
Square
handle bar
40x1000
2 supports

KGS02
40x1200
2 supports

KGS03
40x1400
2 supports

KGS04
40x1600
3 supports

KGS05
40x1800
3 supports

KGS06
40x2000
3 supports

Stainless steel
AT305, AT310,
AT400, AT410,
HT400, HT410

KGS01L
(no image)
40x1000
2 supports with
integrated LED
lighting

KGS03L
(no image)
40x1400
2 supports with
integrated LED
lighting

Stainless steel
AT400, AT410,
HT400, HT410



RGS01
Round
handle bar
Height 1000
2 supports

RGS02
Height 1200
2 supports

RGS03
Height 1400
2 supports

RGS04
Height 1600
3 supports

RGS05
Height 1800
3 supports

RGS06
Height 2000
3 supports

Stainless steel
AT305,
AT310,
AT400,
AT410,
HT400,
HT410



EGS01
Handle bar
Height variable
Stainless steel
AT200,
AT305,
AT310,
AT400,
AT410,
HT400,
HT410

EGS02
Handle bar
(no image)
Height variable
Stainless steel
AT200,
AT305,
AT310,
AT400,
AT410



EGS08
Handle bar
Height variable
Stainless steel
AT310,
AT400,
AT410,
HT400,
HT410

EGS07
Handle bar
(no image)
Height variable
Stainless steel
AT200



EGS06
Handle bar
Height 1130
Stainless steel
AT310,
AT400,
AT410,
HT400,
HT410

EGS05
Handle bar
(no image)
Height 1130
Stainless steel
AT200



MGSE6
Handle strap
40x600

MGSE8
Handle strap
40x800

MGSE10
Handle strap
40x1000

Stainless steel
AT310,
AT400,
AT410,
HT400,
HT410



CS100
Handle bar
Height 1000

Stainless steel
AT200

An elegant selection of handles is available for each door series depending on the design style.

Please note that not every handle is available for every door series.

The handles are not displayed in proportion to each other and not in all material variations.

The dimensions are stated in mm, width x height or Ø.

PUSH AND BOW HANDLES



HS10
Push handle
93x400
stainless steel
AT200, AT305, AT310,
AT400, AT410,
HT400, HT410



HS50
Push handle
109x500
stainless steel
AT200, AT305, AT310,
AT400, AT410,
HT400, HT410



HS40
Push handle
90x500
stainless steel matt
AT200, AT305, AT310,
AT400, AT410,
HT400, HT410



HS42
Push handle
90x500
stainless steel
AT200, AT305, AT310,
AT400, AT410,
HT400, HT410



FS20
Push handle
122x390
stainless steel
AT200, AT305, AT310,
AT400, AT410,
HT400, HT410



TEG14
Push handle
105x450
stainless steel
AT200, AT305, AT310,
AT400, AT410,
HT400, HT410



TEG15
Push handle
48x450
stainless steel
AT200, AT305, AT310,
AT400, AT410,
HT400, HT410



HS32
Push handle
118x477
stainless steel
(HS30 = ring
stainless steel matt)
AT200, AT305, AT310,
AT400, AT410,
HT400, HT410



TEG10
Push handle
110x330
stainless steel
AT200, AT305, AT310,
AT400, AT410,
HT400, HT410



TEG13
Push handle
155x550
stainless steel
AT200, AT305, AT310,
AT400, AT410,
HT400, HT410

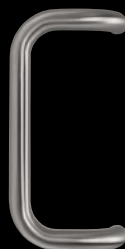

PB30
Tube handle
100x300
stainless steel
(PB31 = aluminium F1)
AT200



PB20
Tube handle
171x350
stainless steel
(PB21 = aluminium F1)
AT200



TEG12
Push handle
110x330
stainless steel
AT200, AT305, AT310,
AT400, AT410,
HT400, HT410



BS10
Push handle
66x340
stainless steel
(BS11 =
brass PVD)
AT200, AT305, AT310,
AT400, HT400



BS42
Push handle
68x340
stainless steel
(BS43 =
brass PVD)
AT200, AT305, AT310,
AT400, HT400



BS23
Push handle
68x340
brass PVD
(BS22 = stainless steel)
AT200, AT305, AT310,
AT400, HT400



GKN201
Stainless steel
AT200

LEVERS



GD25
Stainless steel
AT200, AT305, AT310, AT400,
AT410, HT400, HT410



PD12
Aluminium brushed
AT305, AT310,
AT400, AT410



PD13
Chrome satin
AT200, AT305, AT310, AT400,
AT410, HT400, HT410



PD15
Chrome satin
AT305, AT310,
AT400, AT410



VD20
Chrome matt
AT200, AT305, AT310, AT400,
AT410, HT400, HT410



GD10
Stainless steel
AT200, AT305, AT310, AT400,
AT410, HT400, HT410



GD15
Stainless steel
AT200, AT305, AT310,
AT400, AT410, HT400, HT410



GD20
Stainless steel
AT200, AT305, AT310, AT400,
AT410, HT400, HT410



VD10
Chrome matt
AT200, AT305, AT310,
AT400, AT410, HT400, HT410



VD12
Chrome matt
(VD13 = brass PVD)
AT200, AT305, AT310,
AT400, AT410, HT400, HT410



VD14
Chrome matt
(VD15 = brass PVD)
AT200, AT305, AT310, AT400,
AT410, HT400, HT410



VD16
Chrome matt
AT200, AT305, AT310, AT400,
AT410, HT400, HT410



MD13
Stainless steel
(MD10 = aluminium white)
(MD12 = aluminium natural)
(MD14 = brass PVD)
AT200, AT305, AT310



GD30
Stainless steel
AT200, AT305, AT310,
AT400, AT410, HT400,
HT410

HANDLE PLATE SETS

exclusively for AT 200



VSD10
Chrome matt
(VSK13 = brass PVD)



VSK10
Chrome matt



VSK14
Chrome matt
(VSK15 = brass PVD)



VSD12
Chrome matt
(VSD13 = brass PVD)



VSK12
Chrome matt
(VSK13 = brass PVD)



PZD12
Aluminium natural
(PZD11 = stainless steel)



PSD61
Stainless steel



PSK61
Stainless steel



PSK11
Stainless steel
(PSK12 = aluminium natural)



PSD11
Stainless steel
(PSD12 = aluminium natural)



MSD13
Stainless steel
(MSD10 = RAL9016)
(MSD12 = aluminium natural)
(MSD14 = brass PVD)



MSB12
Aluminium natural
(MSB10 = RAL9016)
(MSB13 = stainless steel)
(MSB14 = brass PVD)



PZK12
Aluminium natural
(PZK11 = stainless steel)



PSD30
Brass PVD



PSK30
Brass PVD



VSD15
Brass PVD
(VSD14 = chrome matt)

HANDLE ACCESSORIES

exclusively for AT 200



84708
Door knocker
100x131 mm
chrome matt
(84707 = brass PVD)



84703
Door knocker
110x177 mm
brass PVD



84701
Door knocker
88x126 mm
brass PVD
(84702 = chrome matt)



OUTSIDE & INSIDE COLOURS

Please note that not every colour is available for every door or frame or door leaf.

Due to printing and manufacturing technology colour deviations between illustrations in this brochure and original products may occur.

Your **Internorm [1st] window partner / distribution partner** will gladly advise you and show you original colour samples.

* **Highly weather-resistant**, except M916 (facade quality).

** Intensive colour appearance, however colour tolerances possible.

*** **HDH colours** have a vibrant timber appearance being hand-finished with structure coating, however colour tolerances are possible.

**** A special highly weather-resistant powder coating is used for surface versions **HM** (highly weather-resistant standard colour), **HF** (highly weather-resistant fine structure), **HFM** (highly weather-resistant fine structure metallic) and **HDH** (highly weather-resistant timber decor colour).

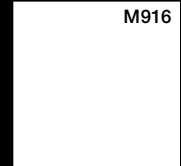

STANDARD COLOURS*



TIMBER DECOR COLOURS***

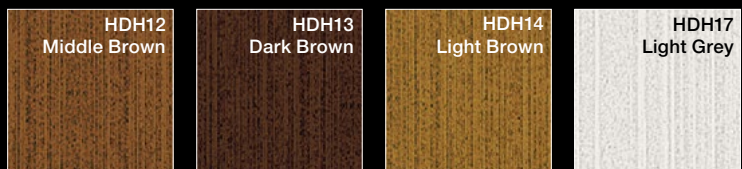

HDS COLOURS**

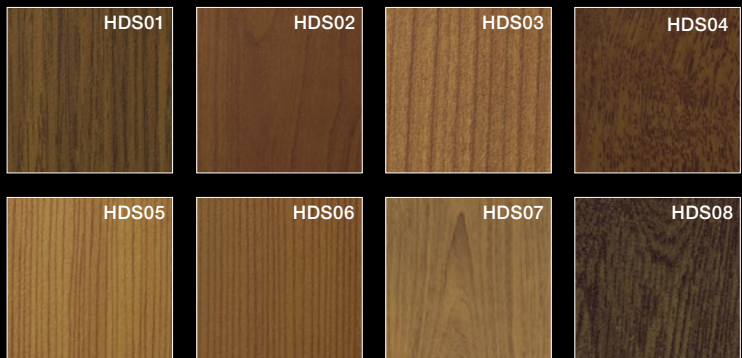

hirest COLOURS****



METALLIC DECOR



STAINLESS STEEL COLOURS

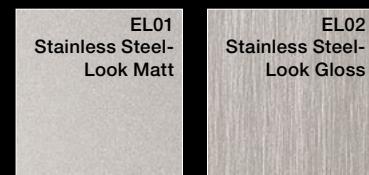

SPECIAL COLOURS

A variety of design possibilities is offered by the Internorm RAL colour range.

OUTSIDE COLOURS

SD COLOURS

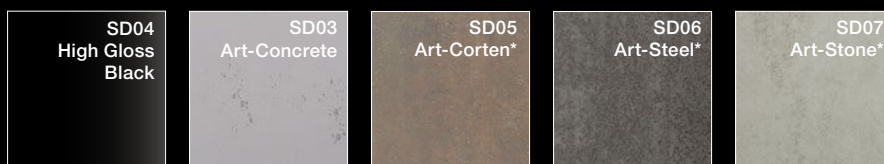

*upon technical request

INSIDE COLOURS

TIMBER STANDARD COLOURS

SPRUCE

varnished

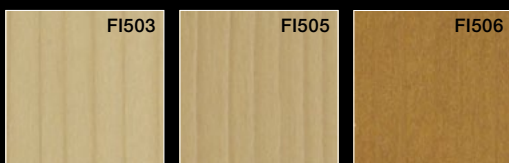

SPRUCE

opaque

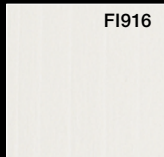

ASH

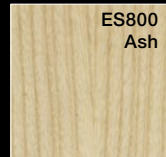

WALNUT

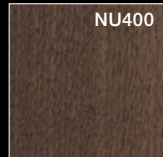

OAK

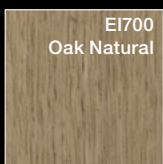
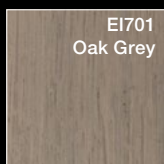

LARCH

varnished

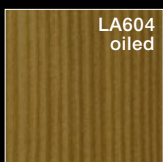





WE ARE OFFERING YOU

TRENDSETTING PRODUCTS FOR SOPHISTICATED CUSTOMERS.

INDIVIDUAL DOORS

Each Internorm door is a unique example as it is manufactured according to your individual specifications and made to measure in our modern manufacturing site in Upper Austria.

We are producing aluminium or timber-aluminium doors for you with flush, square-edged, profiled or rounded door sash design.

A large selection of colours, glazing and handles offers almost limitless design possibilities. **Completely according to your wishes!**

INNOVATIVE TECHNOLOGIES

Our company research department is continuously developing new products and technologies to ensure even more comfort and security for you. We are implementing these developments in our production sites in Austria with the help of most modern technologies.

EXCELLENT QUALITY

Exceptional thermal insulation values and perfect security are matter of fact with Internorm doors. The large numbers of national and international awards and certifications testify of our leading role in development and

manufacture of the most modern windows and doors. We are convinced of our products and our service. Thus we issue warranties which surpass the usual market degree.

PERFECT COMBINATION

Internorm entrance doors can be perfectly combined with any other product from the Internorm range. Same surface structures, colours and glazing enable a design continuity for your house.



TRAUN/UPPER AUSTRIA

Internorm/IFN Headquarters, UPVC window, insulating glass and aluminium production, door production



SARLEINSBACH/UPPER AUSTRIA

UPVC window and insulating glass production, extrusion



LANNACH/STYRIA

Timber-aluminium production

PROFESSIONAL ADVICE

We are only satisfied once you are satisfied! For this reason we have developed the unique Customer Care Program which guarantees you reliable advice and care. More than 1300 distribution partners in 21 countries vouch for this requirement. They accommodate your individual wishes, advise you professionally, take original measurements at your home and provide you with a clear quote.

PROFESSIONAL INSTALLATION

Certified installation specialists of our distribution partners will guarantee you clean and professional installations according to the valid guidelines. After installation they will check all installed products for full functionality with you and will pass on valuable tips for maintenance and care.

WARRANTIES

WE GUARANTEE YOU MANY YEARS OF PLEASURE WITH YOUR INTERNORM WINDOWS.

As Europe's leading and largest active international window brand, Internorm looks back on 87 years of experience in trendsetting window and door solutions of exceptional reliability and longevity. This, we can guarantee you.

Warranty

15
YEARS

- No condensation between the panes of insulating glass up to a glass weight of 80kg.

Warranty

10
YEARS

- No unnatural colour changes or cracked surfaces due to weather influences for white window and door profiles made of UPVC, with the exception of mitre cracks.
- No unnatural colour changes or cracked inside surfaces due to weather influences for foil-coated window and door profiles made of UPVC, with the exception of mitre cracks.
- No unnatural colour changes or cracked surfaces due to weather influences for anodised or powder coated window and door profiles made of aluminium.
- No condensation between the panes of insulating glass.
- The function of the timber, thermal foam and aluminium profile compounds is guaranteed for all Internorm timber/aluminium window systems, provided that the Internorm installation and maintenance guidelines have been adhered to.
- The function of the adhesive and the sealing of insulation glass panes with the window profiles is guaranteed for all Internorm timber/aluminium window systems, provided that the Internorm installation and maintenance guidelines have been adhered to.
- The glue connection of glued Georgian/feature bars.

Warranty

5
YEARS

- PVD coated door handles are guaranteed against corrosion if there is no mechanical change.
- No unnatural colour changes or surface cracks due to weather influences in door fillings. There is no guarantee for changes in the surface appearance as a result of dirt.

Warranty

3
YEARS

- No unnatural colour changes or surface cracks due to weather influences for roller shutter profiles made of UPVC.
- No unnatural colour changes or surface cracks due to weather influences for anodised or powder coated roller shutter and blind profiles made of aluminium.
- The function of the window or door fitting is guaranteed, provided that the Internorm installation and maintenance guidelines have been adhered to.

WARRANTIES/EXCERPT:

The full wording of our warranty conditions, the exact preconditions for the application of the warranty, and what you should do in the event of a claim, can be found in the Internorm Maintenance Care and Warranties Manual. You will receive this booklet when your Internorm products are delivered. In addition, it is obtainable from any Internorm [1st] window partner / distribution partner.



COVER | WINNER INTERNORM ARCHITECTURE COMPETITION 2018 | PRIVATE CONSTRUCTION
Entrance door AT 310 | Window KF 405, KF 410, KS 430

NATIONAL AND INTERNATIONAL CERTIFICATIONS CONFIRM THE HIGH QUALITY OF OUR PRODUCTS.

Our know-how gives you the security that you receive best service for your money. The most modern production facilities and strictest quality controls ensure quality which is setting standards all over Europe. Awards of independent test institutes from all over Europe are confirming this.



Austrian State Emblem



Austrian Quality Label



CE Certification



TÜV



Institute for Window Technology Rosenheim



Plus X Award



RAL Quality Seals



Federal Ministry for Traffic, Innovation and Technology



Technical University Graz



Minergie® Certificate



Austrian Society for Environment Simulation



Certificate for Sustainable Forest Management

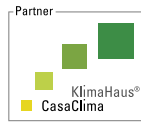

KlimaHaus Certificate



Energy Globe (Projekt Schiesthaus)



Climate Association Town Traun



VinylPlus Certificate



IMPRINT

Publisher: Internorm International GmbH, Ganglgutstraße 131, A-4050 Traun

Photos: Studio Hoflehner, A-4600 Wels | studio46, A-4863 Seewalchen am Attersee

Isa Stein, Studio für Kunst and Architektur, A-4020 Linz | Internorm International GmbH, A-4050 Traun

Design and Litho: Internorm International GmbH, A-4050 Traun

Print: SRPM Limited, Hednesford, WS12 2HA

Subject to technical changes, layout and printing errors.

Internorm International GmbH is an ARA licence partner: Our licence number is 4477.

Internorm®

HEAD OFFICE

Internorm Windows UK Ltd

Unit D, Colindale Business Park
2-10 Carlisle Road, NW9 0HN, London
Tel.: +44 (0) 208 205 9991
Fax: +44 (01) 208 905 8744
Email: office@internorm.co.uk

www.internorm.com